

ALL SERIES

PRODUCT OVERVIEW

Directional
Control Valve

Air Treatment
Unit

Air Cylinder

Electric
Actuator

Vacuum
Component

Tube &
Fitting

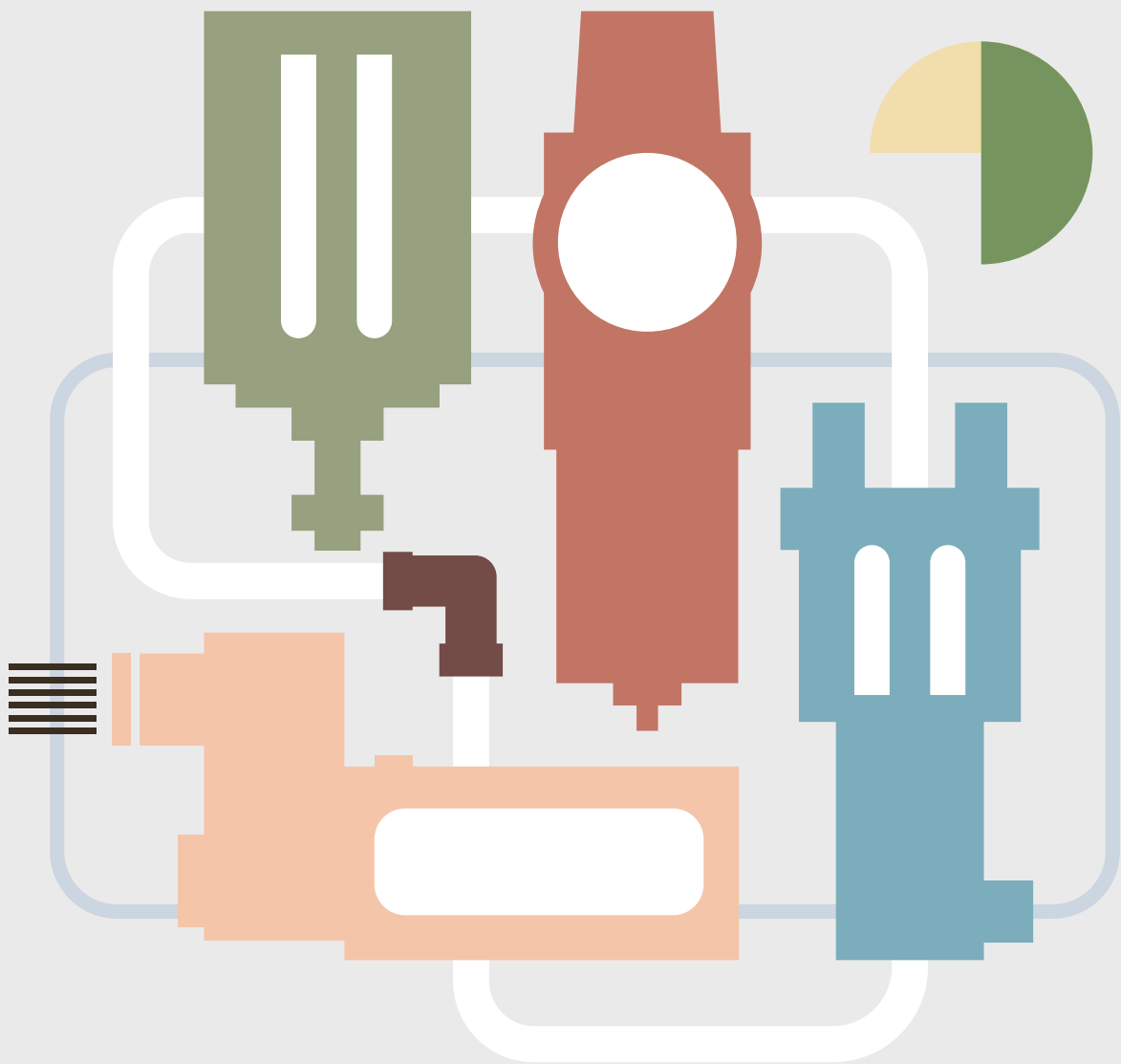

Reservation 

mindman@mindman.com.tw



Scan to visit

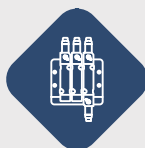

DIRECTIONAL CONTROL VALVE

Solenoid Valve / Pilot & Mechanical Valve

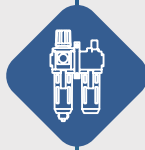

AIR TREATMENT UNIT

F.R.L.Unit / Pressure Switch



AIR CYLINDER

ISO / Table / Stopper / Rodless



GRIPPER & ROTARY ACTUATOR

End of Arm Tooling (EOAT)

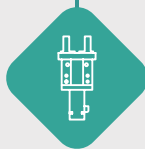

ELECTRIC ACTUATOR

Belt Driven / Ball Screw / Mini. / Gripper

PRODUCT MIX

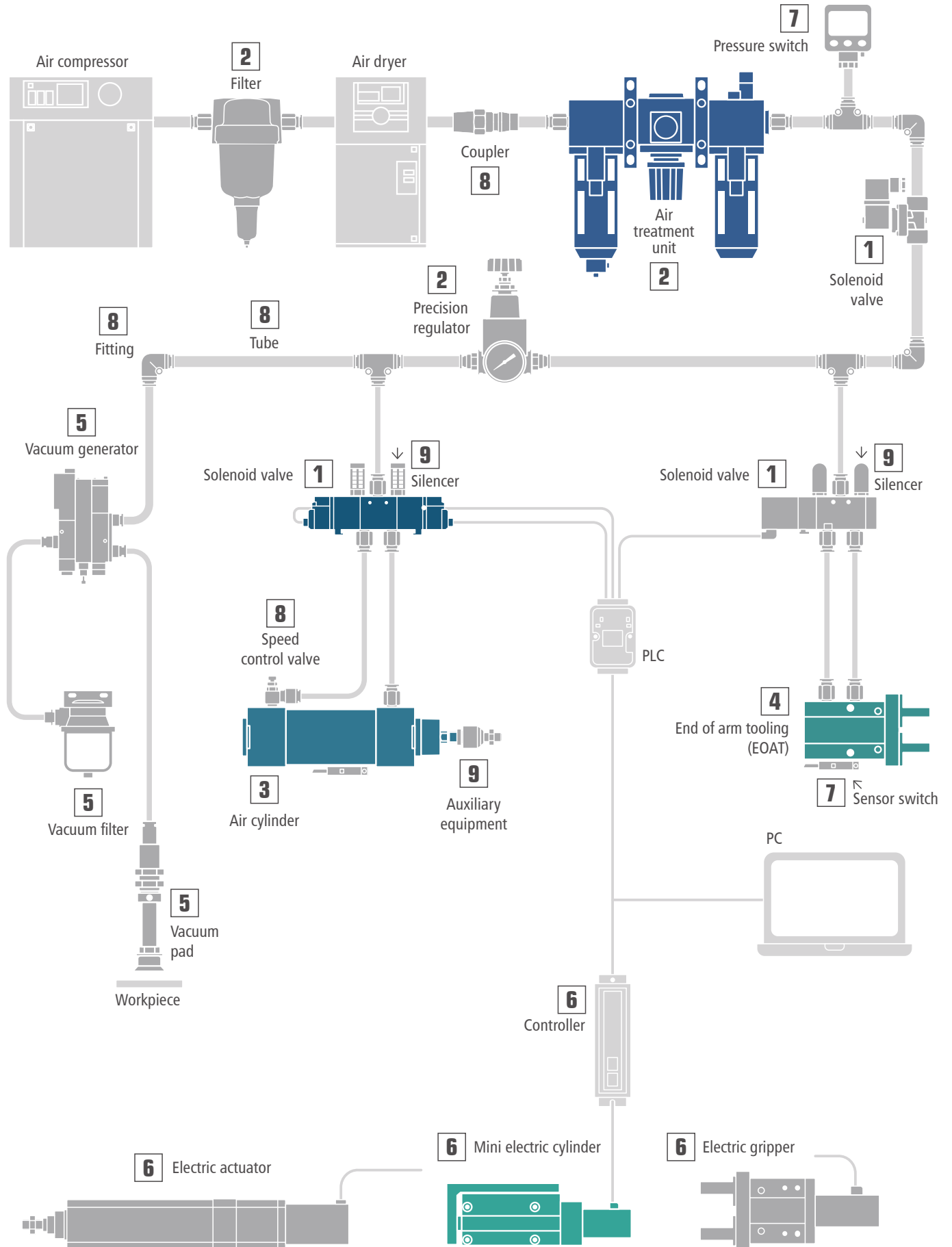

COMPANY BRIEF INTRODUCTION



ISO 9001
Quality

ISO 14001
Environmental Friendly

ISO 45001
Health and Safety

Mindman Industrial Co., Ltd. was established in 1979 with a destination to provide high quality automation components for a wide variety of industries.

During the past 40 years, Mindman has devoted to the expansion of our product range. Thanks to our R&D department, we are proud to possess the diversified product lineup includes solenoid valves, air treatment units, pneumatic cylinders, electric actuators and all different types of fluid power accessories.

We always believe that fast delivery of automation components is the key of success in the market. Through the complete vertical integration of all manufacturing processes and automated warehouse, we are confident to achieve on time delivery.

To keep quality high during the whole production process, we implement the strict quality control standard. We thoroughly control the process via

standard operation procedure (SOP), statistical process control system (SPC) and total productive management (TPM). Most important of all, Mindman commits to providing the products with 100% inspection after assembly.

Currently, Mindman products are exported to more than 90 countries around the world. We devoted ourselves to building the relationship with customers worldwide and provide them with the strong support, such as online 3D drawing, inventory check and promotional program. In the vast automation market, Mindman will spare no effort in establishing a brand – a world-class premium automation components supplier.



CORE BUSINESS

Manufacture and sale of various high-quality automation components

140,000

Automation Products ↑

No.1

Quantity supplied of
pneumatic components
in Taiwan

1979

FOUNDED

ONLINE

SERVICE

INVENTORY INQUIRY

MANUFACTURE BASE

TAINAN

TAIWAN

HEADQUARTERS

TAIPEI

TAIWAN



PRESIDENT

CHING-CHENG HUANG



SALES NETWORK

97 COUNTRIES



EMPLOYEES

600 PEOPLE



MADE IN TAIWAN
100%



CAPITAL
USD 12,558,000



PLANT AREA
90,000 m²

PRODUCTION PROCESS

100% Vertical integration.

Control the quality from materials to final products.

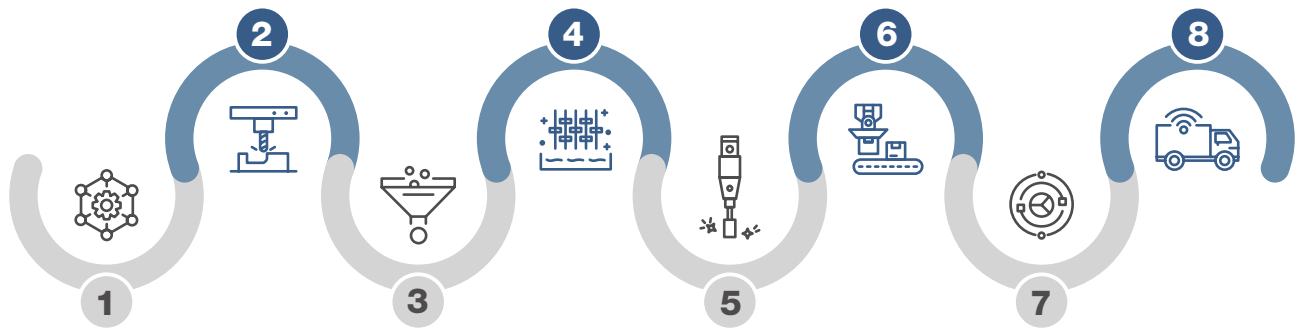

1. Die casting

Production quality is strictly controlled starting from die-casting mold design to final robotic grinding and polishing.

2. Machining

We carry over 300 CNC machines in house and processing more than 100,000 different types of parts.



3. Plastic injection

Automated plastic injection production line with high-precision measuring tools and AOI dimension control system to sustain superb quality.



PRODUCTION PROCESS

4. Surface coating

- Surface pretreatment
- Electric static coating
- Hard anodization
- Impregnation process



5. Grinding

Linear rail grinding, slide block grinding, pull rod grinding etc. are all processed in-house.

6. Product assembling

Utilizing automated assembly machines with software tracking to achieve high-volume and flexible production.



7. 100% Inspection









100% inspection is our commitment to all Mindman customers.

Automated warehouse profile

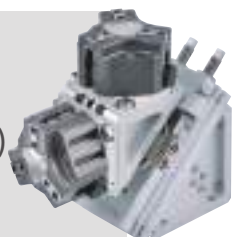
- Plant area: 6600m²
- 84240 stock units
- 99.9% accuracy



CONTENTS

 <p>Directional Control Valve</p>	1	
	2	 <p>Air Treatment Unit</p>
 <p>Air Cylinder</p>	3	
	4	 <p>End of Arm Tooling (EOAT)</p>
 <p>Vacuum Components</p>	5	
	6	 <p>Electric Actuator</p>
 <p>Sensors</p>	7	
	8	 <p>Fittings & Tube (PISCO)</p>
 <p>Auxiliary Equipment</p>	9	
	10	 <p>Hydraulic Cylinder</p>



Directional Control Valve

1

- └ Features and industrial applications1-1
- └ Solenoid valve (3, 5 port)1-2
- └ Solenoid valve (Direct acting type).....1-6
- └ Multi connector system1-6
- └ Fieldbus system1-7
- └ Proportional & Pilot & Mechanical Valve1-8
- └ Hand valve1-9
- └ Shutoff valve.....1-11
- └ Foot pedal valve1-11
- └ Process valve (2, 3 port).....1-12



Air Treatment Unit

2

- └ Features and industrial applications2-1
- └ F.R.L.unit.....2-2
- └ F.R.unit.....2-2
- └ Filter2-3
- └ Auto drainer / Auto drain valve2-3
- └ Pressure regulator.....2-4
- └ Hand-held regulator2-4
- └ Electro-pneumatic regulator2-5
- └ Precision regulator.....2-6
- └ Lubricator2-6
- └ Water separator / Air / Mist / Micro mist filter2-7
- └ Soft start-up valve2-10
- └ High-efficiency compressed air filter2-10
- └ Digital condensation removal timer.....2-10
- └ Pressure gauge2-11
- └ Booster regulator2-11



Air Cylinder

3

- └ Features and industrial applications3-1
- └ Standard cylinder3-2
- └ Rod locking cylinder.....3-4
- └ Power cylinder.....3-4
- └ Compact cylinder3-5
- └ Multi-mount cylinder.....3-7
- └ Mini cylinder3-8
- └ Pen cylinder3-9
- └ Round cylinder.....3-10
- └ High speed cylinder.....3-11
- └ Guide cylinder.....3-11
- └ Table3-14
- └ Rodless cylinder.....3-15
- └ Stopper cylinder3-16
- └ Rotary actuator3-18
- └ Clamp cylinder.....3-19



End of Arm Tooling (EOAT)

4

- └ Features and industrial applications4-1
- └ Parallel gripper (2-Finger)4-2
- └ Parallel gripper (3-Finger).....4-6
- └ Angular gripper 30°, 180°4-6
- └ ALL-IN-ONE pneumatic gripper4-7
- └ Automatic tool changer.....4-8
- └ 180° Rotation gripper4-8
- └ Deburring tool4-9



Vacuum Component

5

- └ Features and industrial applications5-1
- └ Vacuum generator5-2
- └ Rotary vacuum pump5-6
- └ External vacuum controller5-7
- └ No contact transfer5-8
- └ Vacuum pad5-9
- └ Vacuum accessories5-15
- └ Vacuum filter5-16
- └ Vacuum regulator5-17
- └ End of arm tooling (EOAT)5-17



Electric Actuator

6

- └ Features and industrial applications6-1
- └ Slider electric cylinder6-2
- └ Rod type electric actuator6-2
- └ ISO 15552 standard electric actuator6-3
- └ Electric rotary actuator6-3
- └ Electric gripper6-3
- └ Mini electric actuator6-4
- └ Electric stopper actuator6-5
- └ Electric cylinder controller6-5



Sensors

7

- └ Features and industrial applications7-1
- └ Pressure switch7-2
- └ Gap sensor7-3
- └ Multi-controller7-3
- └ Flow sensor7-4
- └ Sensor switch7-5
- └ Linear position sensor7-7
- └ Proximity sensor7-7
- └ Slot-type photomicrosensor7-7



Auxiliary Equipment

9

- └ Features and industrial applications9-1
- └ Floating joint / Rod ends9-2
- └ Shock absorber9-2
- └ Cable with connector / Connector9-3
- └ Jet cooler9-4
- └ Flow control valve9-4
- └ Quick exhaust valve9-4
- └ Shuttle valve / Silencer throttle valve / Check valve ..9-5
- └ Silencer / Pilot check valve / Exhaust cleaner9-5
- └ Hydraulic speed controller9-6
- └ Stainless fitting9-6
- └ Coupler9-6
- └ Pneumatic presses9-7



PISCO Fitting

8

- └ Features and industrial applications8-1
- └ Selection guide - Fitting8-2
- └ Fitting - Type8-4
- └ Release ring color8-6
- └ General environment - Fitting8-7
- └ Special environment - Fitting8-9

PISCO Control Valve

8

- └ Features and industrial applications8-13
- └ Selection guide - Speed controller8-14
- └ General environment - Speed controller8-15
- └ Special environment - Speed controller8-16
- └ Throttle (needle) valve.....8-17
- └ Quick exhaust valve / Pressure regulator8-18
- └ Fixed orifice joint / Regulator.....8-18
- └ Check valve / Filter / Silencer.....8-19
- └ Pressure sensor / Pressure gauge.....8-20

PISCO Tube

8

- └ Features and industrial applications8-21
- └ Selection guide - Tube8-22
- └ General environment -Tube8-24
- └ Special environment - Tube8-27
- └ Accessories8-29

PISCO Change Valve

8

- └ Features and industrial applications8-32
- └ Change valve / Shut-off valve.....8-33

PISCO Plarailchain

8

- └ Features and industrial applications8-34
- └ Plaraichain8-35



Hydraulic Cylinder

10

- └ Features and industrial applications10-1
- └ Hydraulic cylinder10-2
- └ Compact hydraulic cylinder10-2
- └ Round hydraulic cylinder10-3
- └ Hydraulic rotary actuator10-3
- └ Hydraulic lever-type cylinder.....10-4
- └ Hydraulic swing clamp cylinder.....10-4
- └ Hydraulic work support10-4
- └ High oil pressure swing clamping cylinder10-5
- └ Hydraulic threaded-body cylinder.....10-5

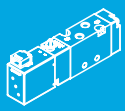

High Wear Resistance



Energy Saving



Quick Response



Low Noise



Longevity



Integration

Directional Control Valve

- U-Packing (NBR)** | DISK seal. High wear resistance, wide working temperature - 30 ~ +100°C , excellent sealability.
- Plunger material** | Resulfurized stainless steel with 17% chromium and 1.5% silicon. Provide a very low coercive field and a very high permeability.
- Terminal material** | Material of terminal housing is PA6 which has good chemical resistance and weather resistance.
- Contact spring** | Contact spring makes wiring quick and easy. Also, it prevents wire damage.
- Coil** | Insulation class H. Heat-resistant to 180°C (the operating temperature of the valve is -5 ~ 50°C).
- Low Noise** | Bridge rectifier design. Converting AC voltage to DC, it can eliminate operating noise.
- Multi connector system** | Simplification and integration reduce air consumption and pressure drop, making less piping and wiring jobs.



New Energy Industry



Textile Industry



Machine Tool



Industry 4.0

MVSC series [with 22 mm coil]

Product features

- **Contact spring**
Contact spring makes wiring quick and easy. Also, it prevents wire damage.
- **Terminal material**
Material of terminal housing is PA6 which has good chemical resistance and weather resistance.
- **Manual override**
Drop-shaped manual override is easy for testing with one push or spin.
- **Applying SurTec 650**
Nonoxidizable for 336hrs under neutral salt spray test.

- **No leakage**
All products go through leakage test according to JIS regulation.

- **DISK seal**  **NBR**
U-packing design
High wear resistance, wide working temperature -30 ~ +100°C, excellent sealability.

- **Coil**
Low power consumption, DC24V power 2W

Insulation class	Coil	F class/ 155°C
	Copper wire	H class/ 180°C

- **Plunger material**
Resulturized stainless steel with 17% chromium and 1.5% silicon. Provide a very low coercive field and a very high permeability.

Product specification

Effective orifice	18 mm ²
Max. operating pressure	0.8 MPa (8 kgf/cm ²)
Ambient temperature	-5 ~ +50°C (No freezing)
Lifetime	50 million cycles under normal service condition



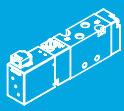

MVSC series



Model	Port size	Port/Position	Effective orifice mm ² (Cv)	Response time ms	Operating pressure MPa	Voltage
MVSC-220	1/8, 1/4	3/2, 5/2, 5/3	16~18 (0.89~1.0)	<40	0.2~0.8	AC110/220V DC12/24V
MVSC-260	1/4	5/2, 5/3	16~18 (0.89~1.0)	<40	0.2~0.8	
MVSC-300	3/8	3/2, 5/2, 5/3	25~35 (1.39~1.94)	<50	0.2~0.8	
MVSC-460	1/2	3/2, 5/2, 5/3	30~60 (1.67~3.33)	<50	0.2~0.8	

MVSC1 series



Model	Port size	Port/Position	Effective orifice mm ² (Cv)	Response time ms	Operating pressure MPa	Voltage
MVSC1-150	M5	5/2	3.8 (0.21)	DC<23, AC<35	0.15~0.8	AC110/220V DC12/24V
MVSC1-180	1/8	3/2, 5/2, 5/3	9~15 (0.5~0.83)	DC<30, AC<45	0.15~0.8	
MVSC1-220	1/8, 1/4	3/2, 5/2, 5/3	16~18 (0.89~1.0)	DC<50, AC<40	0.2~0.8	

MVSD / MVSD1 series



Model	Port size	Port/Position	Effective orifice mm ² (Cv)	Response time ms	Operating pressure MPa	Voltage
MVSD-180	1/8	3/2, 5/2, 5/3	9~15 (0.5~0.83)	<30	0.15~0.8	AC110/220V, DC24V
MVSD1-180	1/8	5/2, 5/3	9~12 (0.5~0.67)	<30	0.15~0.8	AC110/220V, DC24V

MVSE series [High pressure type]



Model	Port size	Port/Position	Effective orifice mm ² (Cv)	Response time ms	Operating pressure MPa	Voltage
MVSE-260	1/4	5/2, 5/3	16~18 (0.89~1.0)	<40	0.2~1.2	AC110/220V DC24V
MVSE-300	3/8	5/2, 5/3	34.5~35 (1.92~1.94)	<50	0.2~1.2	
MVSE-500	1/2	5/2	41 (2.28)	<50	0.2~1.2	
MVSE-510	1/2	5/2	65 (3.61)	<60	0.2~0.7	
MVSE-600	3/4, 1	5/2	96 (5.33), 100 (7.5)	<80	0.2~0.7	

MVSI series [ISO-1 / ISO-3]



Model	Port/Position	Effective orifice mm ² (Cv)	Response time ms	Operating pressure MPa	Voltage
MVSI-260	5/2, 5/3	20, 22 (1.11, 1.22)	<40	0.2~0.7	AC110/220V DC24V
MVSI-450	5/2	27 (1.5)	<40	0.2~0.7	
MVSI-510	5/2	65 (3.61)	<60	0.2~0.7	

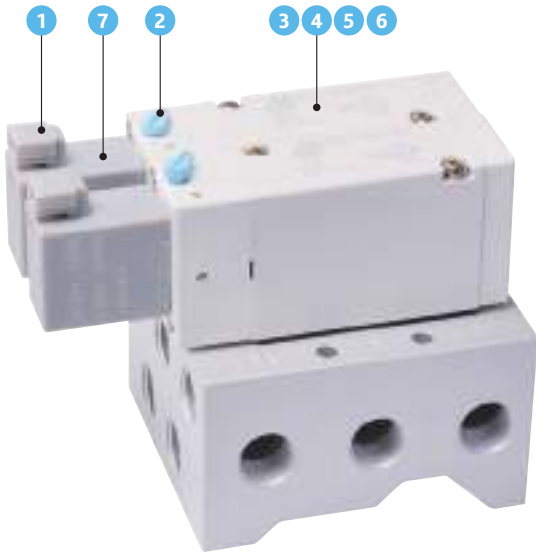

Electric Connection



H : Horizontal plug with LED indicator

W : Lead wire



D : DIN terminal

L : DIN terminal with LED indicator

Coil

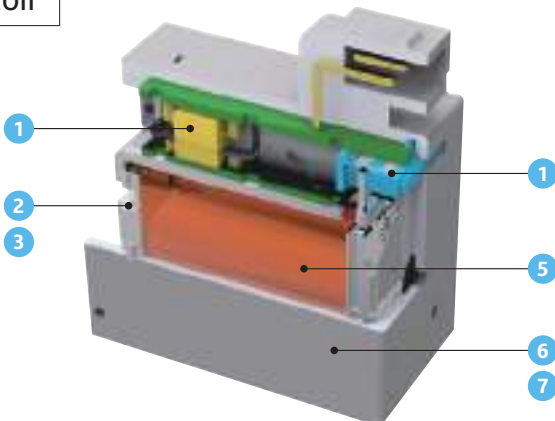

MVSC1 / MVSP series
[with 15 mm coil]

Product features

- 1 **Electrical Connection**
Quick plug design, easy to wiring by socket.
- 2 **Manual override**
Manual override design, easier to test.
- 3 **Quick response**
Quick response time (25~30ms)(DC).
- 4 **DISK seal, U-packing (NBR)**
High wear resistance, wide working temperature - 35 ~ +150°C, excellent sealability, lifetime 50 million cycles.
- 5 **PLC direct drive**
Direct drive from I/O connections of PLC is capable.
- 6 **Applying SurTec 650**
Nonoxidizable for 336hrs under neutral salt spray test.
- 7 **Coil**
Energy saving. Long life.

8 Specifications

	MVSC1	MVSP
Effective orifice	12~38 mm ²	8~27 mm ²
Max. operating pressure	0.8 MPa	0.7 MPa
Ambient temperature	-5 ~ +50°C (No freezing)	
Lifetime	50 million cycles under normal service condition	

Coil features

- 1 **Bridge rectifier design**
Converting AC voltage to DC, it can eliminate operating noise.
- 2 **Low power consumption**
DC power 0.95W, it can save over 70% power consumption compared with other brand (3W).
- 3 **Low current consumption**
It can extend lifetime of driver (PLC, Relay...).
- 4 **Indicator (LED)**
Indicating coil operating condition.
- 5 **Cooper wire insulation class**
H class / 180°C
- 6 **Coil insulation class**
F class / 155°C
- 7 **Low ambient temperature as operating**

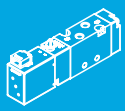

MVSN series [NAMUR]



Model	Port size	Port/ Position	Effective orifice mm ² (Cv)	Response time ms	Operating pressure MPa	Voltage
MVSN-220	1/8, 1/4	5/2	18 (1.0)	<38	0.2~0.8	AC24/110/220V
MVSN-300	1/4	5/2, 5/3	30~35 (1.67~1.94)	<50	0.2~0.8	DC24V

MVSP series



Model	Port size	Port/ Position	Effective orifice mm ² (Cv)	Response time ms	Operating pressure MPa	Voltage
MVSP-156	1/8	5/2, 5/3	8~14.6 (0.45~0.81)	AC<46ms, DC<25ms	0.15~0.7	AC110/220V
MVSP-188	1/4	5/2, 5/3	11~27 (0.61~1.5)	AC<45 ms, DC<33 ms	0.15~0.7	DC12/24V

MVSY series



Model	Port size	Port/ Position	Effective orifice mm ² (Cv)	Response time ms	Operating pressure MPa	Voltage
MVSY-100	M5	5/2, 5/3	4.5~5 (0.25~0.29)	<15	0.2~0.7	AC110/220V
MVSY-156	1/8	5/2, 5/3	8~14.6 (0.45~0.81)	<20	0.15~0.7	DC6/12/24V
MVSY-188	1/4	5/2, 5/3	11~27 (0.61~1.5)	<50	0.15~0.7	

MVSV series [Direct operated] [Low vacuum]



Model	Port size	Port/ Position	Effective orifice mm ² (Cv)	Response time ms	Operating pressure MPa	Voltage
MVSV-220	1/8	3/2	5.2~6.2 (0.29~0.34)	<20	-0.1~0.7	DC24V



MVDA series [Quick Response]

Model	Port size	Port/ Position	Flow rate N l/min	Response time ms	Operating pressure MPa	Voltage
MVDA-80	M5, 1/8	2/2, 3/2	25, 28	ON<2, OFF<1	0~1.2	DC12/24V
MVDA-120	M5	2/2, 3/2	80, 100	ON<5, OFF<2	0~0.8	DC12/24V



MVDC series [Suitable for air, low vacuum]

Model	Port size	Port/ Position	Effective orifice mm ² (Cv)	Response time ms	Operating pressure MPa	Voltage
MVDC-220	1/8	2/2, 3/2	0.8 (0.044)	<20	0~0.7	AC110/220V/DC24V
MVDC-300	1/8, 1/4	3/2	3.9~4.6 (0.22~0.26)	<20	-0.1~1	DC24V

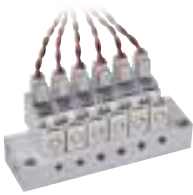

MVDY series

Model	Port size	Port/ Position	Effective orifice mm ² (Cv)	Response time ms (min)	Operating pressure MPa	Voltage
MVDY-100	M5	3/2	P → A: 0.09~0.28 A → R: 0.35	DC<4 ms AC<20ms	0~0.9	AC110/220V DC6/12/24V

Multi Connector System

MVB series

- 25 Pin D-sub connector (MVB series).
- 26 Pin flat cable (MVB1 series).
- Simple electric wire system. Max. operating frequency: 5Hz.



Model	Port size	Port/ Position	Effective orifice mm ² (Cv)	Manifold stations min.~ max.	Applicable solenoid valve
MVB-100	1/8	5/2, 5/3	4.5~5 (0.25~0.29)	2~12	MVSY-100
MVB1-100	1/8	5/2, 5/3	4.5~5 (0.25~0.29)	5~12	MVSY-100
MVB-156	ø4, ø6, ø8	5/2, 5/3	8~14.6 (0.45~0.81)	2~12	MVSY / SP-156
MVB-220	1/8, 1/4	3/2, 5/2, 5/3	16~18 (0.89~1.0)	2~16	MVSC-220
MVB-300	3/8	3/2, 5/2, 5/3	25~35 (1.39~1.94)	3~12	MVSC-300
MVB-460	1/2	3/2, 5/2, 5/3	30~60 (1.67~3.33)	3~12	MVSC-460

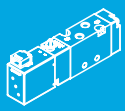

MVJA series EtherNet/IP™

- All-in-one gasket for the base can be easier to increase the number of valve blocks.
- Plug-in design reduces the time for wiring and labor cost.
- 25 Pin D-sub connector.
- The function for communication protocol can be expanded with MVE series.
- The module is compatible with both NPN/PNP.
- Low power consumption (0.55W standard) for solenoid valve.



Model	Port size	Port/ Position	Effective orifice mm ² (Cv)	Manifold stations min.~ max.	Compatible protocol	Connector
MVJA-156	ø6, ø8	5/2, 5/3	7.5~13 (0.42~0.72)	1~12	EtherNet / IP	25 pin D-sub

Fieldbus System

MVE series EtherNet/IP™

- Compatible protocol: EtherNet / IP
- Up to 8 of I/O unit can be connected.
- Wiring time and labor cost can be reduced.
- In addition to the general star type, it is available for linear and ring topologies.
- Short / Open-circuit detection function | The location of error can be identified.
- Counter function | It is possible to ascertain the maintenance period and identify the parts that require maintenance.
- Web server function | Enable status checking and parameter setting by using web browser.
- Input device | Switch | Proximate sensor | Photoelectric switch | Limit switch
- Output device | Valve | Relay | Buzzer | Indicator light

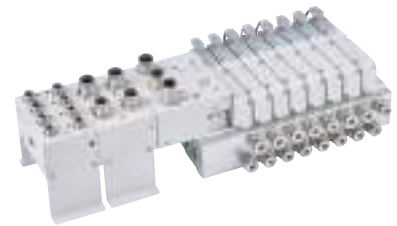

Model	Compatible protocol	Connector	Manifold stations min.~ max.	Applicable solenoid valve
MVE-100	EtherNet / IP	25 pin D-sub	2~12	MVSY-100
MVE-156	EtherNet / IP	25 pin D-sub	2~12	MVSY-156 / MVSP-156

MVE2 series EtherNet/IP™

- Solenoid valve can match different modules.
- Quick tube fittings can be installed.
- Fast troubleshooting thanks to multi-angle LED display.
- It is easy to repair due to solenoid valves can be replaced simple and fast.
- Labor cost can be reduced. Reduce error of wiring.
- Web server function.
- The voltage is DC24V.



Model	Compatible protocol	Fieldbus communication module OUT / IN	Manifold stations min.~ max.	Applicable solenoid valve
MVE2-100	IO-Link, Profinet EtherNet/IP	M12 socket, D-coded (Female)	6,8,12,16	MVSY-100
MVE2-156			6,8,12,16	MVSY-156
MVE2-188	CC-Link IEFB Modbus-RTU	M12 socket, D-coded (Female)	6,8,12,16	MVSY-188
MVE2-220			6,8,12,16	MVSC1-220



MVPH series [High-flow]

- High-flow pressure compensated proportional valve designed primarily for mixing and dosing of gases in ventilation, respiratory equipment, anesthesia, and analytical instruments. Product life: 100 millions.
- Application industry : Printing industry, textile industry, packaging industry, fuel cell.

Model	Ways / Function	Media	Filter of front end µm	Operating pressure MPa	Flow (sl/min)
MVPH	2/2 NC Proportional	Air, oxygen, neutral gases	recommended < 20	0~7	≥ 190 @ 2.4 bar rel. @ 20°C



MVPM series [Precision Flow]

- Direct acting orifice size from $\phi 0.2$ to 2 mm. Pressure up to 12 bar.
- Suited for dosing precisely gases in the medical and in the analytical field.
- Application industry : Gas analysis, chromatography, biotechnology, semiconductor facility, liquid flow.

Model	Ways / Function	Media	Orifice size mm	Operating pressure MPa	Flow (sl/min)
MVPM	2/2 NC Proportional	Air, oxygen, neutral gases	$\phi 0.2 \sim \phi 2$	0~12	≥ 3.8 ~ ≥ 70 @ 12 bar rel. @ 20°C

Pilot Valve

MVAA series



Model	Port size	Port/ Position	Operating pressure MPa	Effective orifice mm ²
MVAA-150	M5	5/2	0~0.8	3.8
MVAA-180	1/8	3/2, 5/2	0~0.8	12
MVAA-220	1/4	3/2, 5/2, 5/3	0~0.8	18
MVAA-260	1/4	5/2	0~0.8	18
MVAA-300	3/8	3/2, 5/2, 5/3	0~0.8	35
MVAA-460	1/2	3/2, 5/2, 5/3	0~0.8	50

Mechanical Valve



MVMA series [Roller Lever]

Model	Port size	Port/ Position	Operating pressure MPa	Effective orifice mm ²
MVMA-260	1/4	5/2	0~0.8	18
MVMA-300	3/8	5/2	0~0.8	35

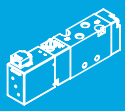

MVMB series [Button]

Model	Port size	Port/ Position	Operating pressure MPa	Effective orifice mm ²
MVMB-220	1/4	3/2, 5/2	0.15~0.8	18
MVMB-250	1/4	2/2, 3/2	0~1	18
MVMB-300	3/8	5/2	0.15~0.8	30



MVMC series [Button]

Model	Port size	Port/ Position	Operating pressure MPa	Effective orifice mm ²
MVMC-210	1/8, 1/4	3/2	0~1	19



EPA series

Model	Type	Port size	Port	Operating pressure MPa
EPA-100	Pin plunger	1/8	3	0~0.9
EPA-100A	Ball actuator	1/8	3	0~0.9
EPA-101	Retained toggle	1/8	3	0~0.9
EPA-101A	Toggle	1/8	3	0~0.9
EPA-102	Palm button	1/8	3	0~0.9
EPA-103	Roller plunger	1/8	3	0~0.9
EPA-104	Pilot	1/8	3	0~0.9
EPA-105	Roller lever	1/8	3	0~0.9
EPA-106	One way lever	1/8	3	0~0.9
EPA-107	Plain lever	1/8	3	0~0.9
EPA-108	Push button	1/8	3	0~0.9
EPA-109	Selector	1/8	3	0~0.9



Hand Valve

MVHF series

Model	Port size	Port/ Position	Stem travel Stroke/ Arc of travel	Max. operating pressure psig max.	Effective orifice mm ²	Medium
MVHF-2P/3P N.C.	1/8	3/2	1/8 Travel	150	7.2	Air
MVHF-3P N.O.	1/8	3/2	1/8 Travel	150	5.7	Air
MVHF-3V	1/8	3/2	60°	150	–	Air, water, oil
MVHF-5V	1/8	5/2	80°	150	4.3	Air, water, oil
MVHF-5P	1/8	5/2	1/8 Travel	150	8.6	Air, water, oil
MVHF-AP	10-32, 1/8	Single action	–	150	–	Air
MVHF-LB	90° angle, heavy duty mounting bracket for clippard miniature valves					
MVHF-PB	Manual push button (valve actuators)					





MVHA series

Model	Port size	Port/ Position	Operating pressure MPa	Effective orifice mm ²
MVHA-2	M5	2/2, 3/2	0~0.9	1.8
MVHA-3	M5	2/2, 3/2	0~0.9	1.8
MVHA-4	M5	5/2	0~0.9	1.9
MVHA-31	1/8	3/2	0~0.9	4.5
MVHA-41	1/8	5/2	0~0.9	5.5



MVHA series [Manual / Mech. Operator]

Model	Type	Material
MVHA-34T	Fingertip operator	Nickel-plated steel
MVHA-34C	Cam operator	Level: Nickel-plated steel, Roller: POM
MVHA-34CW	One-way cam operator	Level: Nickel-plated steel, Roller: POM
MVHA-34B	Ball operator	Level: Nickel-plated steel, Ball: Chrome steel
MVHA-34A	Air pilot operator	Nickel-plated brass



MVHB series

Model	Port size	Port/ Position	Operating pressure MPa	Effective orifice mm ²
MVHB-220	1/4	5/2, 5/3	0~0.8	16~18
MVHB-260	1/4	5/2, 5/3	0~0.8	18
MVHB-300	3/8	5/2, 5/3	0~1.2	34
MVHB-500	1/2	5/2, 5/3	0~1.2	41



MVHD series

Model	Port size	Port/ Position	Operating pressure MPa	Effective orifice mm ²
MVHD-220	1/8, 1/4	3/2, 5/2	0~0.8	18

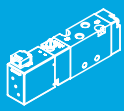
**MVHS series**

Model	Port size	Operating pressure MPa	Effective orifice mm ²
MVHS	1/4, 3/8, 1/2, 3/4	0.05~1	P → A: 30.4~85.4, A → R: 34.1~90.7

**MVHC series**

Model	Port size	Port	Operating pressure MPa	Effective orifice mm ²
MVHC	1/8, 1/4, 3/8, 1/2, 3/4	4	0.05~1	7~71

Shutoff Valve**MVHT series**

Model	Port size	Port/ Position	Operating pressure MPa	Model for F.R.L
MVHT-302	1/4, 3/8, 1/2	2/2, 3/2	0~1.5	MA**302
MVHT-400	1/4, 3/8, 1/2	2/2, 3/2	0~1.5	MA**401, 403

**MVHR series [Manual type / Solenoid type (S)]**

Model	Port size	Port/ Position	Operating pressure MPa	Model for F.R.L	Voltage Solenoid type (S)
MVHR-302 (S)	1/4, 3/8, 1/2	3/2	0.1~1	MA**302	AC110V, 220V (50/60)Hz,
MVHR-400 (S)	1/4, 3/8, 1/2	3/2	0.1~1	MA**401, 403	DC24V

Foot Pedal Valve**MVFA series**

Model	Port size	Port/ Position	Operating pressure MPa	Effective orifice mm ²
MVFA	1/4	3/2, 4/2	0.2~7	8

Selection table *Seal-code N NBR, J EPDM, V Viton, T Teflon, R RUBY, Z FFKM, S Silicon

Model	Inside structure			N.C.	N.O.	Fluid						Material		Port size	CV	
	Piston	Diaphragm	Plunger			Water / Air	Hot water	Steam	Light oil	Heavy oil	Gas	Vacuum	Body			Seal
MBS			○	●		●			●		●	●	Brass	N,J,V,T,Z	M5,1/8,1/4	0.03~0.40
MBD			○	●		●			●		●	●	Forged brass	N,V	1/4~1/2	0.14~0.95
MCS			○	●		●			●		●	●	Forged brass	N,J,V,T,R,Z	1/4~3/4	0.10~1.30
MED		○		●		●			●		●		Forged brass	N,J,V	1/4~1/2	1.1~2.2
MEP			○	●		●			●				Forged brass	N,J,V	3/8,1/2	2.4
MGA	○			●		●		●					Forged brass	N,J,V	3/8,1/2	1.9~2.6
MGS	○			●		●		●	●				Forged brass	T	3/8,1/2	1.9~2.6
MGD		○		●		●					●		Forged brass	N,J,V	3/8~2	2.0~31
MJS			○	●		●			●		●	●	Brass	N,J,V	—	0.08~0.32
MJR			○	●		●			●		●	●	Brass	N,J,V	—	0.10~0.42
MPD		○		●		●							PA (Nylon)	N,J,V	3/8~1	1.6~11
MPK		○		●		●							PA (Nylon)	N,J,V	3/8~1	1.6~11
MRB			○		●	●			●		●		Brass	V	1/8,1/4	0.05~0.09
MRC			○		●	●			●		●		Brass	N,J,V	1/8~3/8	0.10~0.31
MUCL *1			○	●		●			●		●		SUS #303	N,J,V,T,Z	1/8,1/4	0.03~0.27
MUPH		○		●					Corrosive fluid				PVC/PTFE	T	1/4~3/4	0.11~2.5
MUSC			○	●		●			●		●	●	SUS #303	N,J,V,T,R,Z	1/8~3/8	0.03~1.30
MUSD		○		●		●			●		●		SCS14	N,J,V	1/2	2.0
MUSK		○		●		●			●		●	●	SCS14,#303	N,J,V	1/2	2.0
MUSL *1		○		●		●			●		●		SCS14	N,J,V	1/2	2.0
MWA	○			●		●			●		●		Brass	N	3/8~2	3.0~31
MWH	○			●								●	Brass	V	3/8~2	3.0~31
MWS	○			●		●		●	●				Brass	T	3/8~2	3.0~31
2/2 WAY MWD		○		●		●					●		Forged brass	N,J,V	3/8~2	3.0~31
2/2 WAY MWK		○		●		●			●		●	●	Forged brass	N,J,V	3/8~2	3.0~31
MYA	○			●		●		●					Forged brass	N,J,V	3/8,1/2	1.9~2.6
MYS	○			●		●		●	●				Forged brass	T	3/8,1/2	1.9~2.6
MZS			○	●		●			●		●	●	Forged brass	N,J,V,T,R,Z	1/8~1/2	0.1~0.8
MUD			○	●	●	●			●		●	●	Brass	N,J,V,S	1/8~1/2	0.23~0.79
MUS-6~10			○	●					●				Brass	T	1/8~3/8	0.32~0.54
MUDC		○		●					Corrosive fluid				PVC/PTFE	T	1/4~1	0.28~4
MSUS	○		○	●	●	●			●	●	●	●	SUS #304	N,J,V,T,S	1/8~2	0.23~48
MUAO	○			●		●					●		Brass	N	1/4~1/2	2.5
MUW		○		●		●			●				Forged brass	N,J,V,S	3/8~2	4.5~48
MUW-NO		○		●	●	●			●		●	●	Forged brass	N,J,V,S	3/8~2	4.5~48
MUW-F		○		●	●	●			●				FC-20	N,J,V,S	1 1/4~4	22~180
MUG		○		●							●		Forged brass	N	3/8~2	4.5~48
MUV		○		●								●	Forged brass	N	3/8~2	4.5~48
MUAW	○			●		●							Cast bronze	N	1/2~2	4~48
MUS	○			●					●	●	●		Cast bronze	T	1/2~2	4~48
MUS-F	○			●		●			●	●			FC-20	J,V,T,S	1 1/4~4	22~175
MSUW		○		●	●	●			●		●	●	SUS #304	N,J,V,S	1/2~2	4.5~48
MSUW-F		○		●		●			●		●	●	SUS #304	N,J,V,S	1/2~2	4.5~48
MUPS	○			●		●			●	●			Cast bronze	J,V,T,S	1/2~1	4~12
MXAD			○	●		●			●		●	●	Forged brass	N,J,V,S	1/8~1/2	0.26~0.97
MXAD-AF		○		●		●			●		●	●	Forged brass	N,J,V,S	3/8~2	4.5~48
MXCD		○		●		●			●				Forged brass	N,V	1/4~1/2	2.4~2.7
MXPV		○		●		●			●				Forged brass	N,J,V,S	3/8~3/4	4.5~9.3

Model	Inside structure			N.C.	N.O.	Fluid						Material		Port size	CV	
	Piston	Diaphragm	Plunger			Water / Air	Hot water	Steam	Light oil	Heavy oil	Gas	Vacuum	Body			Seal
3/2 WAY MCT			○	●		●			●		●	●	Forged brass	N,J,V,Z	1/4~3/4	0.02~0.65
MJT			○	●		●			●		●	●	Brass	N,J,V	—	0.10~0.42
MRJ			○		●	●			●		●	●	Brass	N,J,V	—	0.10~0.31
MUST			○	●		●			●		●	●	SUS#303	N,J,V,Z	1/8~3/8	0.03~0.65
MUT			○	●	●	●			●	●	●	●	Forged brass	V	1/8~3/8	0.02~0.31
MZT			○	●		●			●		●	●	Forged brass	N,J,V,Z	1/8~1/2	0.05~0.65
MUA			○	●		●			●			●	Brass	N,V	1/4,3/8	0.1~0.12

*1. MUCL, MUSL are Latch valve.

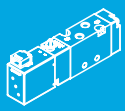
**MBS series [2/2 way N.C. plunger type]**

- Available fluid: Air, gas, water, vacuum, oil etc.

Model	Body mat'l	Port size	Seal mat'l	Flow coefficient	Operating pressure	Coil power
				Cv	0~ bar	AC / DC
MBS	Brass	M5, 1/8, 1/4	NBR, EPDM, Viton Teflon, FFKM	0.03~0.4	AC: 1~30 DC: 0.1~30	AC: 5.3~8 VA DC: 5.2~6.8 W

MBD series [2/2 way N.C. plunger type direct acting]

- Available fluid: water, air, gas, light oil, vacuum.

Model	Body mat'l	Port size	Seal mat'l	Flow coefficient	Operating pressure	Coil power
				Cv	0~ bar	AC / DC
MBD	Forged brass	1/4, 3/8, 1/2	NBR, Viton	0.14~0.95	AC: 1.5~25 DC: 0.5~20	AC: 5.7~23 VA DC: 5.2~18.5 W

MCS series [2/2 way N.C. plunger type direct acting]

- Available fluid: water, air, gas, vacuum, light oil (below 50cst.) etc.

Model	Body mat'l	Port size	Seal mat'l	Flow coefficient	Operating pressure	Coil power
				Cv	0~ bar	AC / DC
MCS	Forged brass	1/4, 3/8 1/2, 3/4	NBR, EPDM, Viton Teflon, Ruby, FFKM	0.1~1.3	AC: 0.4~40 DC: 0.4~30	AC: 8.6~24 VA DC: 10~18.5 W

MCT series [3/2 way N.C. plunger type]

- Available fluid: water, air, gas, vacuum, light oil (50 cst down) etc.

Model	Body mat'l	Port size	Seal mat'l	Flow coefficient	Operating pressure	Coil power
				Cv	0~ bar	AC / DC
MCT	Forged brass	1/4, 3/8 1/2, 3/4	NBR, EPDM Viton, FFKM	0.02~0.65	AC/DC 0.8~16	AC: 8.6~24 VA DC: 10~18.5 W

MED series [2/2 way N.C. diaphragm type]

- Available fluid: water, air, gas, light oil.

Model	Body mat'l	Port size	Seal mat'l	Flow coefficient	Operating pressure	Coil power
				Cv	0.3~ bar	AC / DC
MED	Forged brass	1/4, 3/8, 1/2	NBR, EPDM, Viton	1.1~2.2	AC: 4~10 DC: 2~7	AC: 5.3~8 VA DC: 5.2~6.8 W

MEP series [2/2 way N.C. plunger type direct acting]

- Available fluid: water, air

Model	Body mat'l	Port size	Seal mat'l	Flow coefficient	Operating pressure	Coil power
				Cv	0~ bar	AC / DC
MEP	Forged brass/ SUS plate	3/8, 1/2	NBR, EPDM, Viton	2.4	AC: 0.2~1.2 DC: 0.1~0.5	AC: 9.2~23 VA DC: 10~18.5 W



MGA / MGS series [2/2 way N.C. piston type]

- Available fluid: water, air and higher temp. fluids

Model	Body mat'l	Port size	Seal mat'l	Flow coefficient Cv	Operating pressure bar	Coil power AC / DC
MGA	Forged brass	3/8, 1/2	NBR, EPDM, Viton	1.9~2.6	AC: 0.3~16 DC: 0.3~10	AC: 9.2~33 VA DC: 10~18.5 W
MGS	Forged brass	3/8, 1/2	Teflon	1.9~2.6	0.3~10	AC: 15.4~33 VA DC: 15~18.5 W



MGD series [2/2 way N.C. diaphragm type]

- Available fluid: water, air, gas

Model	Body mat'l	Port size	Seal mat'l	Flow coefficient Cv	Operating pressure 0.3~ bar	Coil power AC / DC
MGD	Forged brass	3/8~2	NBR, EPDM, Viton	2~31	AC: 8~16 DC: 5~16	AC: 5.3~19.5 VA DC: 5.2~15 W



MJS / MJR series [2/2 way N.C. plunger type]

- Available fluid: water, air, gas, oil, vacuum

Model	Body mat'l	Orifice mm	Seal mat'l	Flow coefficient Cv	Operating pressure 0~ bar	Coil power AC / DC
MJS	Brass	1.6~3.5	NBR, EPDM, Viton	0.08~0.32	AC: 5~40, DC: 4~30	AC: 9.2~23 VA DC: 10~18.5 W
MJR	Brass	1.6~3.5	NBR, EPDM, Viton	0.1~0.42	AC: 2~40, DC: 2~30	



MJT / MRJ series [3/2 way N.C., N.O. plunger type]

- Available fluid: water, air, gas, oil, vacuum

Model	Body mat'l	Orifice mm	Seal mat'l	Flow coefficient Cv	Operating pressure 0~ bar	Coil power AC / DC
MJT N.C.	Brass	Body 1.6~3.5, Top 1.6~2.5	NBR, EPDM	0.1~0.42	AC/DC: 2~20	AC: 9.2~23 VA DC: 10~18.5 W
MRJ N.O.	Brass	Body 2.0~3.5, Top 1.6~3.0	Viton	0.1~0.31	AC/DC: 1~10	



MPD / MPK series [2/2 N.C. diaphragm type]

- Available fluid: water, air

Model	Body mat'l	Port size	Seal mat'l	Flow coefficient Cv	Operating pressure 0.2~ bar	Coil power AC / DC
MPD	PA (Nylon)	3/8, 1/2, 3/4, 1	NBR, EPDM, Viton	1.6~1f1	AC: 3.5~7, DC: 0.8~3.5	AC: 6.9~18 VA DC: 6.2~18.5 W
MPK	PA (Nylon)	3/8, 1/2, 3/4, 1	NBR, EPDM, Viton	1.6~11	AC: 4~7, DC: 0.8~7	



MRB / MRC series [2/2 N.O. plunger type]

- Available fluid: water, air, gas, light oil.

Model	Body mat'l	Port size	Seal mat'l	Flow coefficient Cv	Operating pressure 0~ bar	Coil power AC / DC
MRB	Brass	1/8, 1/4	Viton	0.05~0.09	AC/DC: 8~10	AC: 5.3~6.9 VA DC: 5.2~6.2 W
MRC	Brass	1/8, 1/4, 3/8	NBR, EPDM, Viton	0.1~0.31	AC/DC: 5~24	AC: 9.2~33 VA DC: 10~18.5 W

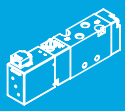

MUCL series [2/2 way N.C. plunger type]

- Available fluid: water, air, gas, light oil (below 50cst) etc.
- Energy-saving, blocking hazardous fluid.
- Valve open when power on, then power shut off, valve still open. Change to opposite pole, valve close.

Model	Body mat'l	Port size	Seal mat'l	Flow coefficient Cv	Operating pressure 0~ bar	Coil power DC
MUCL	SUS #303	1/8, 1/4	NBR, EPDM, Viton Teflon, FFKM	0.03~0.27	4~15	DC 6/12/24 V 6.9/6.9/6



MUPH series [2/2 way N.C. diaphragm type]

- Available fluid: sulfuric acid, hydrochloric acid, chemically corrosive fluids.

Model	Body mat'l	Port size	Seal mat'l	Flow coefficient Cv	Operating pressure 0~ bar	Coil power AC / DC
MUPH	Teflon, PVC	1/4, 3/8 1/2, 3/4	Teflon	0.11~2.5	0.4~5	AC: 21/30 VA DC: 18.5/25 W



MUSC series [2/2 way N.C. plunger type direct acting]

- Available fluid: water, air, gas, light oil (below 50cst.), vacuum.

Model	Body mat'l	Port size	Seal mat'l	Flow coefficient Cv	Operating pressure 0~ bar	Coil power AC / DC
MUSC	SUS #303	1/8, 1/4	NBR, EPDM, Viton Teflon, FFKM	0.03~0.4	AC: 1.0~30 DC: 0.1~30	AC: 5.3~24 VA DC: 5.2~18.5 W
MUSC	SUS #303	1/4, 3/8	NBR, EPDM, Viton Teflon, Ruby, FFKM	0.1~1.3	AC: 0.4~40 DC: 0.4~30	



MUSD series [2/2 way N.C. diaphragm type]

- Available fluid: water, air, gas, light oil

Model	Body mat'l	Port size	Seal mat'l	Flow coefficient Cv	Operating pressure 0.3~ bar	Coil power AC / DC
MUSD	SUS #SCS14	1/2	NBR, EPDM, Viton	2	AC: 4~10 DC: 3~7	AC: 5.3~8 VA DC: 5.2~6.8 W



MUSK series [2/2 way N.C. pilot diaphragm type]

- Available fluid: water, air, gas, light oil, vacuum etc.

Model	Body mat'l	Port size	Seal mat'l	Flow coefficient Cv	Operating pressure 0.3~ bar	Coil power AC / DC
MUSK	SUS #SCS14 body SUS #304 cover	1/2	NBR, EPDM, Viton	2	AC: 4~9 DC: 3~7	AC: 5.3~8 VA DC: 5.2~6.8 W



MUSL series [2/2 way N.C. diaphragm type]

- Available fluid: water, air, gas, light oil
- Energy-saving, blocking hazardous fluid.

Model	Body mat'l	Port size	Seal mat'l	Flow coefficient Cv	Operating pressure 0~ bar	Coil power DC
MUSL	SUS #SCS14	1/2	NBR, EPDM, Viton	2	4.5~5	DC 6/12/24 V 6.9/6/6



MUST series [3/2 way N.C. plunger type]

- Available fluid: water, air, gas, light oil (below 50cst.) , vacuum.

Model	Body mat'l	Port size	Seal mat'l	Flow coefficient Cv	Operating pressure 0 ~ bar	Coil power AC / DC
MUST	SUS #303	1/8, 1/4, 3/8	NBR, EPDM Viton, FFKM	0.03~0.65	AC/DC: 0.8~12	AC: 5.3~24 VA DC: 5.2~18.5 W



MUT series [3/2 way N.C., N.O. plunger type]

- Available fluid: water, air, gas, light oil, heavy oil (Max. 120 cst.), vacuum.

Model	Body mat'l	Port size	Seal mat'l	Operating pressure 0 ~ bar	Coil power AC / DC
MUT	Forged brass	1/8, 1/4, 3/8	Viton	AC: 1.5~14 DC: 0.7~14	AC: 5.3~23 VA DC: 5.2~18.5 W



MWA / MWH / MWS series [2/2 way N.C. plunger type]

- Available fluid: air, water, light oil, gas, heavy oil, high viscosity fluids (Max. 120 cst), steam, high temp. fluids etc.

Model	Body mat'l	Port size	Seal mat'l	Flow coefficient Cv	Operating pressure 0.5~ bar	Coil power AC / DC	Fluid
MWA	Forged brass	3/8~2	NBR	3~31	AC: 3~16, DC: 1~10	AC	air, water, light oil, gas
MWH		3/8~2	Viton	3~31	AC: 3~15, DC: 1~10	9.2~33 VA DC	heavy oil, high viscosity fluids
MWS		3/8~2	Teflon	3~31	AC: 3~10, DC: 1~7	10~18.5 W	steam, high temp. fluids



MWD / MWK series [2/2 way N.C. diaphragm type]

- Available fluid: water, air, gas, light oil, vacuum.

Model	Body mat'l	Port size	Seal mat'l	Flow coefficient Cv	Operating pressure 0.2 ~ bar	Coil power AC / DC
MWD	Forged brass	3/8~2	NBR, EPDM, Viton	3~31	AC: 0.5~16, DC: 0.5~4	AC: 9.2~23 VA
MWK		3/8~2	NBR, EPDM, Viton	3~31	AC: 1~16, DC: 1~4	DC: 10~18.5 W



MYA / MYS series [2/2 way N.C. piston type]

- Available fluid: water, air and high temp. fluids.

Model	Body mat'l	Port size	Seal mat'l	Flow coefficient Cv	Operating pressure 0~ bar	Coil power AC / DC
MYA	Forged brass	3/8, 1/2	NBR, EPDM, Viton	1.9~2.6	AC: 0.3~20 DC: 0.3~12	AC: 9.2~33 VA DC: 10~18.5 W
MYS	Forged brass	3/8, 1/2	Teflon	1.9~2.6	AC: 0.3~10 DC: 0.3~7	



MZS series [2/2 way N.C. plunger type direct acting]

- Available fluid: water, air, gas, light oil (below 50cst.), vacuum etc.

Model	Body mat'l	Port size	Seal mat'l	Flow coefficient Cv	Operating pressure 0~ bar	Coil power AC / DC
MZS	Forged brass	1/8, 1/4 3/8, 1/2	NBR, EPDM, Viton Teflon, Ruby, FFKM	0.1~0.8	AC: 2.5~40 DC: 2~30	AC: 8.6~24 VA DC: 10~18.5 W

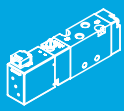

MZT series [3/2 N.C. plunger type direct acting]



- Available fluid: water, air, gas, vacuum, light oil (below 50cst.) etc.

Model	Body mat'l	Port size	Seal mat'l	Flow coefficient Cv	Operating pressure 0~ bar	Coil power AC / DC
MZT	Forged brass	1/8, 1/4 3/8, 1/2	NBR, EPDM, Viton, FFKM	0.05~0.65	AC/DC: 0.8~12	AC: 8.6~24 VA DC: 10~18.5 W

MUD / MUS series [2/2 way N.C., N.O. plunger type]



- Available fluid: water, air, steam, light oil, gas, vacuum

Model	Body mat'l	Port size	Seal mat'l	Flow coefficient Cv	Operating pressure MPa	Coil power Torr	Fluid
MUD N.C.	Brass	1/8, 1/4, 3/8, 1/2	NBR	0.18~0.79	0~2	0~10 ⁻³	Water, air, light oil, gas, vacuum
MUD N.O.	Brass	1/8, 1/4, 3/8	NBR	0.18~0.79	0~2	0~10 ⁻³	
MUS N.C.	Brass	1/8, 1/4, 3/8	Teflon	0.23	0~1	—	Steam, light oil

MUA series [3/2 way N.C. plunger type]



- Available fluid: water, air, vacuum

Model	Body mat'l	Port size	Seal mat'l	Flow coefficient Cv	Operating pressure MPa	Vacuum Torr
MUA	Brass	1/4, 3/8	NBR	0.1~0.12	0~1	0~10 ⁻³

MUDC series [2/2 way N.C. diaphragm type]



- Available fluid: Air, water, corrosive fluid (PH 0~14)

Model	Body mat'l	Port size	Seal mat'l	Flow coefficient Cv	Operating pressure MPa
MUDC	PVC	1/4, 3/8, 1/2, 3/4, 1	Synthetic rubber	0.28~3.5	0~0.1
MUDC-TF	Teflon	1/4, 3/8, 1/2, 3/4, 1	Synthetic rubber	0.28~4	0~0.1

MSUS series [2/2 way N.C., N.O. plunger type]



- Available fluid: water, air, steam, gas, light oil, vacuum

Model (Low flow)	Body mat'l	Port size	Seal mat'l	Flow coefficient Cv	Operating pressure MPa	Vacuum Torr
MSUS N.C.	SUS #304	1/8, 1/4, 3/8	NBR, Teflon, Viton	0.23~0.58	0~1	0~10 ⁻³
MSUS N.O.	SUS #304	1/8, 1/4, 3/8	NBR, Teflon	0.23~0.58	0~1	0~10 ⁻³

MSUS series [2/2 way N.C., N.O. plunger type]



- Available fluid: water, air, steam, light oil.

Model (High flow)	Body mat'l	Port size	Seal mat'l	Flow coefficient Cv	Operating pressure MPa
MSUS N.C.	SUS #304	1/2~2	Teflon	4~48	0.05~1
MSUS N.O.	SUS #304	1/2~2	Teflon	4~48	0.05~1



MUAO series [2/2 way N.C., N.O. plunger type]

- Available fluid: water, air, heavy oil.

Model	Body mat'l	Port size	Seal mat'l	Flow coefficient	Operating pressure
				Cv	MPa
MUAO	Brass	1/4, 3/8, 1/2	NBR	2.5	0.05~1.5



MUW series [2/2 way diaphragm type]

- Available fluid: **W** water, **W** air, **LO** light oil, **G** gas, **VA** vacuum

Model	Body mat'l	Port size	Seal mat'l	Flow coefficient	Operating pressure MPa		Vacuum	Fluid
				Cv	Standard	High	Torr	
MUW N.C.	Forged brass	3/8~2	NBR	4.5~48	0~0.7	0.05~2	-	W LO
MUW N.O.	Forged brass	3/8~2	NBR	4.5~48	0~0.7	-	0~10 ⁻³	W LO G VA
MUW-F N.C.	FC-20	1 1/4~4	NBR	22~180	0.05~0.8	-	-	W LO
MUW-F N.O.	FC-20	1 1/4~4	NBR	22~180	0.05~0.8	-	-	W LO



MUG / MUV series [2/2 way N.C. diaphragm type]

Model	Fluid	Body mat'l	Port size	Seal mat'l	Flow coefficient	Operating pressure MPa	Vacuum
					Cv	MPa	Torr
MUG	Gas	Forged brass	3/8~2	NBR	4.5~48	0~0.7	-
MUV	Vacuum	Forged brass	3/8~2	NBR	4.5~48	-	0~10 ⁻³



MUAW series [2/2 way N.C. piston type]

- Available fluid: water, air

Model	Body mat'l	Port size	Seal mat'l	Flow coefficient	Operating pressure
				Cv	MPa
MUAW	Cast bronze	1/2~2	NBR	4~48	0.05~1.5



MUS series [2/2 way N.C. piston type]

- Available fluid: **W** water, **W** air, **T** steam, **LO** light oil, **HO** heavy oil

Model	Body mat'l	Port size	Seal mat'l	Flow coefficient	Operating pressure		Fluid
				Cv	MPa	MPa	
MUS	Cast bronze	1/2~2	Teflon	4~48	0.05~1	-	T LO HO
MUS-F	FC-20 Cast Iron	1 1/4~4	Teflon	22~175	0.1~1	-	T W LO



MSUW series [2/2 way N.C., N.O. diaphragm type]

- Available fluid : **W** water, **W** air, **G** gas, **LO** light oil, **VA** vacuum

Model	Body mat'l	Port size	Seal mat'l	Flow coefficient	Operating pressure MPa		Vacuum	Fluid
				Cv	Standard	High	Torr	
MSUW N.C.	SUS #304	1/2~2	NBR	4.5~48	0~0.7	0.05~2	0~10 ⁻³	W LO VA
MSUW N.O.	SUS #304	1/2~2	NBR	4.5~48	0~0.7	-	0~10 ⁻³	W G LO VA
MSUW-F N.C.	SUS #304	1/2~2	NBR	4.5~48	0~0.7	0.05~2	0~10 ⁻³	W LO VA

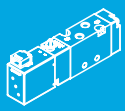
**MUPS series [2/2 way N.C. piston type]**

- Available fluid: water, air, steam, light oil.

Model	Body mat'l	Port size	Seal mat'l	Flow coefficient	Operating pressure
				Cv	MPa
MUPS	Cast bronze	1/2, 3/4, 1	Teflon	4~12	0.05~1

**MXAD series [2/2 way N.C. plunger type direct acting]**

- Available fluid: water, air, light oil, gas, vacuum.

Model	Body mat'l	Port size	Seal mat'l	Flow coefficient	Operating pressure 0~ bar		
				Cv	Brass	SUS	Vacuum Torr
MXAD	Brass	1/8, 1/4	NBR, Viton Silicon, EPDM	0.26~0.97	1~10	2~10	0~10 ⁻⁶
	SUS	3/8, 1/2					

**MXAD-AF series [2/2 way N.C. diaphragm type direct acting]**

- Available fluid: water, air, light oil, gas, vacuum.

Model	Body mat'l	Port size	Seal mat'l	Flow coefficient	Operating pressure 0~ bar		
				Cv	Brass	SUS	Vacuum Torr
MXAD-AF	Brass	3/8~2	NBR, Viton Silicon, EPDM	4.5~48	5~10	7~10	0~10 ⁻⁶
	SUS						

**MXCD series [2/2 way N.C. diaphragm type]**

- Available fluid: water, air, light oil.

Model	Body mat'l	Port size	Seal mat'l	Flow coefficient	Operating pressure 0~ bar	
				Cv	Brass	SUS
MXCD	Brass, SUS	1/4, 3/8, 1/2	NBR, Viton	2.4~2.7	0.3~20	0.2~20

**MXPV series [2/2 way N.C. diaphragm type]**

- Available fluid: water, air, light oil.

Model	Body mat'l	Port size	Seal mat'l	Flow coefficient	Operating pressure 0~ bar	
				Cv	Brass	SUS
MXPV	Brass, SUS	3/8, 1/2, 3/4	NBR, Viton Silicon, EPDM	4.5~9.3	0.5~10	0.2~20



Heat Treatment Technology | High Protection | Self-Locking Mechanism | Efficient Water Removal | Remote Monitoring | Diverse Modularization

Air Treatment Unit

- Tempering treatment** | Tempering treatment makes the inner case more solid and reduces fracture possibility when operating.
- Protection** | Body with SurTec 650 surface treatment enhance the resistance of oxidation from acidbase.
- Self-locking** | Pressed-in and self-locking mechanism to ensure stability.
- Filter** | Water removal rate 93%, 99%(Precision) °
- Precision regulator** | Repeatability under $\pm 0.5\%$ F.S.
- Remote monitoring** | Achieve remote monitoring through the feedback of electric signal and stepless control of the thrust force.
- Diversified combination** | Diversified modular products can be applied in the different instances.



Medical Industry



New Energy Industry



Semiconductor Industry



Food Industry

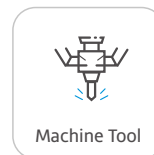

Machine Tool



Industry 4.0



MACP series

Model	Port size	Operating pressure MPa	Lubricating oil capacity c.c	Min. flow for oil drip ℓ / min	Filter element μm
MACP200	1/8, 1/4	0.05~1	20	35, 50	40, 5
MACP200L	1/8, 1/4	0.05~1	35	35, 50	40, 5
MACP302	1/4, 3/8, 1/2	0.05~1	65	50, 60, 60	5, 40
MACP400	1/4, 3/8, 1/2	0.05~1	200	100, 200, 400	40, 5
MACP401	1/4, 3/8, 1/2	0.05~1.5	200	30, 65, 80	40, 5
MACP403	1/4, 3/8, 1/2	0.05~1	200	30, 65, 80	40, 5
MACP501	3/4, 1	0.05~1	200	25, 33	40



MACT series

Model	Port size	Operating pressure MPa	Lubricating oil capacity c.c	Min. flow for oil drip ℓ / min	Filter element μm
MACT200	1/8, 1/4	0.05~1	20	35, 50	40, 5
MACT200L	1/8, 1/4	0.05~1	35	35, 50	40, 5
MACT302	1/4, 3/8, 1/2	0.05~1	65	50, 60, 60	5, 40
MACT400	1/4, 3/8, 1/2	0.05~1	200	100, 200, 400	40, 5
MACT401	1/4, 3/8, 1/2	0.05~1.5	200	30, 65, 80	40, 5
MACT403	1/4, 3/8, 1/2	0.05~1	200	30, 65, 80	40, 5
MACT501	3/4, 1	0.05~1	200	25, 33	40

F. R. Unit



MAFR series

Model	Port size	Operating pressure MPa	Drain capacity cm ³	Filter element μm
MAFR100	M5	0.05~1	3.5	5, 40
MAFR200	1/8, 1/4	0.05~1	9.5	40, 5
MAFR200L	1/8, 1/4	0.05~1	25	40, 5
MAFR302	1/4, 3/8, 1/2	0.05~1	35	5, 40
MAFR400	1/4, 3/8, 1/2	0.05~1	100	40, 5
MAFR401	1/4, 3/8, 1/2	0.05~1.5	70	40, 5
MAFR403	1/4, 3/8, 1/2	0.05~1	75	40, 5
MAFR501	3/4, 1	0.05~1.5	70, 75	40



MAF series

Model	Port size	Operating pressure MPa	Drain capacity cm ³	Removal ratio %	Rated flow ℓ / min	Filter element μm
MAF200	1/8, 1/4	0.05~1	9.5	–	–	40, 5
MAF200L	1/8, 1/4	0.05~1	25	–	–	40, 5
MAF302	1/4, 3/8, 1/2	0.05~1	35	–	–	5, 40
MAF302G ^{*1}	1/4, 3/8, 1/2	0.05~1	35	99±1	550, 1280	–
MAF400	1/4, 3/8, 1/2	0.05~1	100	–	1500~2200	40, 5
MAF401	1/4, 3/8, 1/2	0.05~1.5	70	–	1500~2500	40, 5
MAF403	1/4, 3/8, 1/2	0.05~1	75	–	–	40, 5
MAF501	3/4, 1	0.05~1.5	70, 75	–	–	40
MAF900	1 1/2	0.05~1.75	–	99	20000	50
MAF901	2	0.05~1.75	–	–	63000	50

*1. Water separator

Auto Drainer



MAD series

Model	Port size	Operating pressure MPa	Discharge per operation c.c.
MAD400	1/4, 3/8, 1/2	0.05~1	–
MAD401	1/2	0.1~1.3	–
MAD401H	1/2	0.1~1.3	–
MAD500	1/2 (Inlet), 3/8 (Outlet)	0.13~1.3	60/ per on time. Max. operation 25 times per minute.
MAD501	1/2 (Manual outlet) 3/8, 5/16"HOSE (Automatic outlet)	0.05~1	–

Auto Drain Valve



FMRF / MADV series

Model	Port size	Operating pressure MPa
FMRF300	ø8 (I.D.)	0.15~1
MADV400-WA	1/8 (female thread)	0.05~1.3
MADV400-WB	M1/8 (male thread)	0.05~1.3

MAR series



Model	Port size	Operating pressure MPa	Regulated pressure MPa	Repeatability
MAR100	M5	1	0.05~0.7	±10% F.S.
MAR200	1/8, 1/4	1	0.05~0.85	-
MAR302	1/4, 3/8, 1/2	1	0.05~0.85	-
MAR400	1/4, 3/8, 1/2	1	0.05~0.85	-
MAR401	1/4, 3/8, 1/2	1.5	0.1~0.85, 0.1~1.5	-
MAR403	1/4, 3/8, 1/2	1	0.1~0.85	-
MAR501	3/4, 1	1.5	0.05~0.85	±7% F.S.
MAR900	1 1/2	2.1	0.09~0.86	-
MAR901	2	3.1	max. 1.75	-



MAHR series [High pressure type]

Model	Type	Port size	Max. operating pressure MPa	Regulated pressure MPa
MAHR200	Standard	1/4	3.5	0~1
MAHR200	High pressure (H)	1/4	3.5	0~2.7

Hand-Held Regulator

MAR300LK series

- Design: No convex shaft, small size and high transportability. Anodized aluminum body to achieve lightweight. (80g around)
- The outlet pressure can be observed through the scale of adjustment knob to determine. The lock mechanism can prevent rotation by accidentally.
- The unique structure of adjustment knob enables the pressure regulation to be completed within one turning round.
- Outlet pressure can be directly exhausted by turning back the adjustment knob.



Model	Port size	Max. operating pressure MPa	Regulated pressure MPa	Proof pressure MPa	Weight g
MAR300LK	1/4	1.5	0.3~0.9	3.75	80

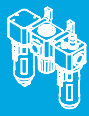

1

Stepless control

Stepless control of air pressure proportional to an electrical signal.

High precision pressure control

Achieve high precision pressure control with microcomputer PID.

Certification Comply with IP65 and CE certification.

1

Regulator performance

Linearity	±1 less (F.S.)
Hysteresis	±0.5 less (F.S.)
Repeatability	±0.5 less (F.S.)
Sensitivity	±0.2 less (F.S.)

2

Compatible with modular

MAER200, 210 can be assembled with MA**302 series.

MAER300, 310 can be assembled with MA**401 / 403 series.

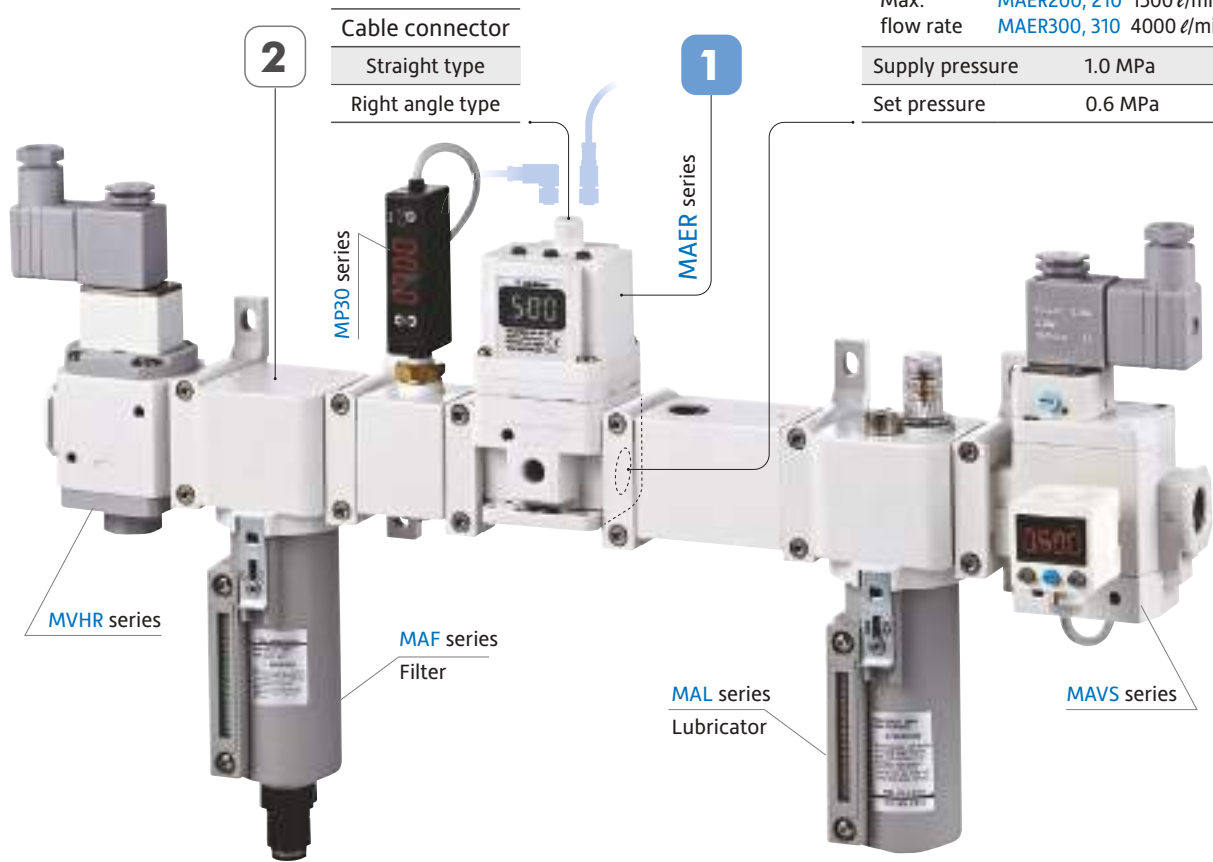

Max. flow rate	MAER200, 210 1500 ℓ/min MAER300, 310 4000 ℓ/min
Supply pressure	1.0 MPa
Set pressure	0.6 MPa

Energy saving piping

Simplify complex pipeline for controlling different pressure. Space saving, Reduce cost, Energy saving.

VS

Traditional piping

Tradition piping for multi-stage air pressure.

$$\text{MAER} = \text{MAR} + \text{MV}^* \times n \text{ set}$$

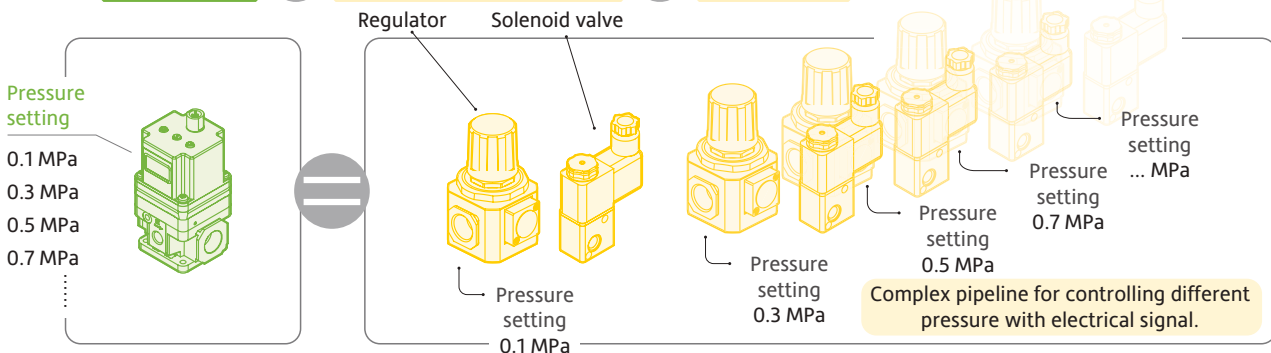



MAER series

- Stepless control of air pressure proportional to an electrical signal.
- Simplify complex pipeline for controlling different pressure.
- Compatible with modular.
- Achieve high precision pressure control with microcomputer PID.
- Maximum flow rate 1500 & 4000 l /min (Supply pressure 1.0 MPa, Set pressure 0.6 MPa).
- Comply with IP65 and CE certification.

Model	Port size	Max. operating pressure MPa	Output pressure display % F.S. ±1 digit	Enclosure	Compatible with modular
MAER200	1/4, 3/8	1	±2	IP65	MA*302 series
MAER300	1/4, 3/8, 1/2	1	±2	IP65	MA*401, 403 series

[Communication type]

Model	Port size	Max. operating pressure MPa	Output pressure display % F.S. ±1 digit	Communication Protocol	Compatible with modular
MAER210	1/4, 3/8	1	±2	RS-232, RS-485	MA*302 series
MAER310	1/4, 3/8, 1/2	1	±2	RS-232, RS-485	MA*401, 403 series

Precision Regulator



MAIR series

- Convenient design, quick mounted bracket, can also be installed on the panel.
- Can be used with mechanical or electronic digital pressure gauge.
- Compared with the MAR series, low pressure drop problem, better flow characteristics.
- Compact & lightweight.
- Compatible with modular.

Model	Port size	Max. operating pressure MPa	Regulated pressure MPa	Repeatability % F.S.	Air consumption ℓ /min(ANR) F.S.	Compatible with modular
MAIR100	1/8	1	0.005~0.8	±0.5	4.4	–
MAIR200	1/4	1	0.005~0.8	±0.5	4.4	MA*302 series
MAIR300	1/4, 3/8, 1/2	1	0.005~0.8	±0.5	11.5	MA*401, 403 series

Lubricator



MAL series

Model	Port size	Max. operating pressure MPa	Lubricating oil capacity c.c	Min. flow for oil drip ℓ / min	Max. flow rate ℓ / min
MAL200	1/8, 1/4	1	20	35, 50	–
MAL200L	1/8, 1/4	1	35	35, 50	–
MAL302	1/4, 3/8, 1/2	1	65	50, 60, 60	–
MAL400	1/4, 3/8, 1/2	1	200	100, 200, 400	400, 1300, 2500
MAL401	1/4, 3/8, 1/2	1.5	200	30, 65, 80	1200, 2000, 2100
MAL403	1/4, 3/8, 1/2	1	200	30, 65, 80	–
MAL501	3/4, 1	1.5	200	25, 33	–
MAL900	1 1/2	1.75	1000	204	12000

MAMG

EWS

Water separator
Removal rate 99%±1



Separating the water droplet with a special filtration in the compressed air. * cannot remove moisture.



MAMB

E3

3 μm
Filtration efficiency 99%



Removing the impurities which the particles are bigger than 3μm in compressed air, and extending the life of precision filter in the down-stream, then preventing trouble with the equipment.

MAMD

E03

0.3 μm
Filtration efficiency 99.9%



Removing the oil mist and impurities which the particles are bigger than 0.3μm in compressed air.

MAMM

E001

0.01 μm
Filtration efficiency 99.9%



Removing the oil mist and impurities which the particles are bigger than 0.01μm in compressed air. The filter can be applied to requirement of high purity and extremely low oil mist.

MAMF

E001D

0.01 μm + Deodorization
Filtration efficiency 99.9%



Adsorbing the odor and efficiently removing oil mist with an activated carbon element in compressed air. The filter can be applied to requirement of high purity and oil-free, such as precision painting operations or food and medical equipment. * Assembling a MAMD series as pre-filter to extend the life of activated carbon.

Body & Port size

[Rc, G, NPT thread]

- MAM*25** 1/4, 3/8
- MAM*35** 3/8, 1/2
- MAM*45** 1/2, 3/4
- MAM*55** 3/4, 1

Model & Filter element

Water separator
MAMG

Precision filter

- MAMB** 3 μm
- MAMD** 0.3 μm
- MAMM** 0.01 μm
- MAMF** 0.01 μm + Deodorization

Maintenance

Replace filter element at least once per year or when pressure drop reaches 0.07 MPa. (E001D every 6 months)



Differential pressure indicator (Option)

Double-check with a **Sensor switch** and an indicator to achieve preventative maintenance.

Caution

This product can't be operated in a location in which pulsations frequently occur. The indicator is only available with Indicator (Q) and Indicator with switch (QR) models.

Operation image



Initial (No clogging)



Replacement recommended

Replacement Required Mark

An indicator that can confirm intuitively.
A clear cover and colorful lamp enables high visibility.
A mark that help you know when it is time to replace the filter element.

Sensor switch (Option)



RDFE(V)

- Solid state output, Normally open
- Operating voltage: 5~30V DC
- Switching current: 50mA max.

A hint for preventative maintenance

Generally speaking, the filter element should be replaced about once a year. This is just a guideline. The air cleanliness of the secondary side depends on working conditions. To keep your system at optimal conditions, we recommend that

Customers replace filter elements regularly / follow the Replacement mark.



Precision Filter

MAF* / MAT* series



Model	Port size	Operating pressure MPa	Drain capacity cm ³	Filter element µm
MAF200D/M	1/8, 1/4	0.05~1	6.5	D:0.3, M:0.01
MAF200LD/M	1/8, 1/4	0.05~1	20	D:0.3, M:0.01
MAF302D/M	1/4, 3/8, 1/2	0.05~1	35	D:0.3, M:0.01
MAF401A/D/M	1/4, 3/8, 1/2	0.05~1.5	70	A:5, D:0.3, M:0.01
MAFF401AD/DM	1/4, 3/8, 1/2	0.05~1.5	70+70	AD:5+0.3, DM:0.3+0.01
MAFR401AD	1/4, 3/8, 1/2	0.05~1.5	70+70	AD:5+0.3
MATFR401	1/4, 3/8, 1/2	0.05~1.5	70+70+70	5+0.3+0.01
MAF501D/M	3/4, 1	0.05~1.5	75, 70	D:0.3, M:0.01

Precision Filter · Water Separator

MAMG series [Water separator]

- Separating the water droplet with a special filtration in the compressed air. * cannot remove moisture.



Model	Port size	Operating pressure MPa	Nominal flow capacity ℓ / min (0.7 MPa)	Removal rate %	Compatible with modular
MAMG25	1/4, 3/8	0.05~1	650	99±1	MA*401-W MA*403 series
MAMG35	3/8, 1/2	0.05~1	1350	99±1	
MAMG45	1/2, 3/4	0.05~1	2100	99±1	MA*501 series
MAMG55	3/4, 1	0.05~1	3600	99±1	MA*501 series

MAM* series [Air/ Mist/ Micro mist filter]

- Adsorbing the order and efficiently removing oil mist with an activated carbon element in compressed air. The filter can be applied to requirement of high purity and oil-free, such as precision painting operations or food and medical equipment.
- Assembling a MAMD series as pre-filter to extend the life of activated carbon.

Model	Body size	Port size	Operating pressure MPa	Nominal flow capacity ℓ / min (0.7 MPa)	Filter element µm	Compatible with modular
MAMB	25	1/4, 3/8	0.05~1	650	3	MA*401, MA*403 series
	35	3/8, 1/2	0.05~1	1350	3	
	45	1/2, 3/4	0.05~1	2100	3	MA*501 series
	55	3/4, 1	0.05~1	3600	3	MA*501 series
MAMD	25	1/4, 3/8	0.05~1	650	0.3	MA*401, MA*403 series
	35	3/8, 1/2	0.05~1	1350	0.3	
	45	1/2, 3/4	0.05~1	2100	0.3	MA*501 series
	55	3/4, 1	0.05~1	3600	0.3	MA*501 series
MAMM	25	1/4, 3/8	0.05~1	500	0.01	MA*401, MA*403 series
	35	3/8, 1/2	0.05~1	1000	0.01	
	45	1/2, 3/4	0.05~1	2000	0.01	MA*501 series
	55	3/4, 1	0.05~1	3600	0.01	MA*501 series
MAMF	25	1/4, 3/8	0.05~1	500	0.01+Deodorization	MA*401, MA*403 series
	35	3/8, 1/2	0.05~1	1000	0.01+Deodorization	
	45	1/2, 3/4	0.05~1	2000	0.01+Deodorization	MA*501 series
	55	3/4, 1	0.05~1	3600	0.01+Deodorization	MA*501 series



MAVS series

- Start-up valve for low speed air supply to gradually raise initial pressure in an air system and for quick exhaust by cutting off air supply.
- Combination with modular type air units (F.R.L. unit).
- Adaptor possess smooth pressure relief is optional.

Model	Port size	Operating pressure MPa	Effective orifice mm ²	Voltage AC / DC	Compatible with modular
MAVS200	1/4	0.25~1	1(P)→2(A): 20, 2(A)→3(R): 24	AC110/220V,DC24V	–
MAVS300	3/8	0.25~1	1(P)→2(A): 37, 2(A)→3(R): 49	AC110/220V,DC24V	MA*302 series
MAVS400	1/2	0.25~1	1(P)→2(A): 61, 2(A)→3(R): 76	AC110/220V,DC24V	MA*401 MA*403 series

High Efficiency Compressed Air Filter



MJF / MJL series [Ported / Flanged]

- Air filter engineering original imported top quality filter element 98% voids volume provides long life time with lowest operating cost. Pleated media provides far more filter surface, therefore more dirt holding capacity, lower diff. pressure and lower running cost compare to conventional wrapped element designs.
- A. Filter media: AFE uses high performance borosilicate microfiber with 98% void volume. The pleated design assures the highest possible filtration area within the element geometry to provide low operating cost.
- B. End cap: An O-ring sealed alumina end cap for the highest possible operating temperature together with tie rod construction provides highest possible security against pressure spikes in the compressed air system.
- C. Stainless steel support sleeves: Inner and outer SS support sleeves for supporting the filter media, incl. a mechanical pre-separation.

Model	Port size	Operating pressure barG	Max. capacity		Oil removal mg/m ³	Filter element μ
	inch		Nm ³ /min	SCFM		
MJF	1/2~2 1/2	16	1.6~25	56~882	0.003~0.1	0.01, 1, 3
MJL	1/2~2 1/2, 3"~8"FL	10	1.6~150	56~5295	0.003~0.1	0.01, 1, 3

Digital Condensation Removal Timer



MBS / MCS / MBD series [Automation control systems]

- The Digital Condensation Removal Timer is a compact, modular timer valve combination specifically designed for air line condensation removal. This digital timer is compatible with MBS/ MCS/MBD series valve size to obtain an optimal system.
- This device easily programmed by two press-keys and a LCD display.
- Timer is water and dust protected to IP65 when installed properly to a coil and connector with provided M3 screw.

Model	Port size	Seal mat'l	Flow coefficient Cv	Operating pressure 0~ bar	Coil power AC / DC
MBS	M5, 1/8, 1/4	NBR, EPDM Viton, Teflon	0.03~0.18	AC: 1~30 DC: 0.1~30	AC: 5.3~8 VA DC: 5.2~6.8 W
MCS	1/4, 3/8, 1/2, 3/4	NBR, EPDM, Viton Teflon, Ruby, FFKM	0.1~1.3	AC: 0.4~40 DC: 0.4~30	AC: 8.6~24 VA DC: 10~18.5 W
MBD	1/4, 3/8, 1/2	NBR, Viton	0.14~0.95	AC: 1.5~25 DC: 1.5~20	AC: 5.7~23 VA DC: 5.2~18.5 W



MPG-60 series [Digital pressure gauge]

- 6 user programmable pressure units (kPa, MPa, kgf/cm², psi, bar, mmHg) available.
- Battery powered, Back light option.
- Easy / fast read out with digital display.
- Power saving mode.
- LCD display: 3 1/2 digital, 7 segment LCD display (Black)
- IP65 enclosure, dust and splash-proof.

Model	Rate / display pressure range	Proof pressure	Operating pressure	Programmable pressure unit
MPG-60V	-101 ~ 0 kPa / -101 ~ 10 kPa	300 kPa	±1% F.S. ±1digit	psi, bar mmHg, kPa
MPG-60P	0 ~ 1 MPa / -0.1 ~ 1 MPa	1.5 MPa	±0.2% F.S. ±1digit	psi, bar, kfg/cm ² , MPa



PG series

Model	Port size	Pressure range *2 MPa	Precision	Proof pressure
PG-20	—	10K	±4% F.S.	The max. scale of gauge times 1.2
PG-20W *1	—	10K	±4% F.S.	
PG-25	1/16	10K	±4% F.S.	
PG-33S *1	1/8	2K, 4K, 10K	ASME B class	
PG-40	1/8	1K, 2K, 3K, 4K, 5K, 10K, 20K	ASME B class	
PG-40W *1	1/8	1K, 2K, 3K, 4K, 5K, 10K, 20K	ASME B class	
PG-40S *1	1/8	2K, 4K, 10K	ASME B class	
PG-50	1/4	10K, 20K	ASME B class	

*1. W: White, S: Stainless steel

*2. 1K: 0~0.1 MPa, 2K: 0~0.2 MPa, 3K: 0~0.3 MPa, 4K: 0~0.4 MPa 5K: 0~0.5 MPa, 10K: 0~1 MPa, 20K: 0~2 MPa

Booster Regulator

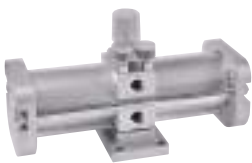

MVBA-2100 series

- Increase factory air pressure by up to twice as much.
- Air-only operation requires no power supply, reduces heat generation, and allows easy installation.

Model	Pressure increase rate	Port size	Operating pressure MPa	Max. flow rate ℓ/min
MVBA-2100	Twice	3/8	0.2~1	1000



MVBAT series [with air tank]

- Increase the primary pressure in the air line up to twice.
- Air-only operation requires no power supply, reduces heat generation, and allows easy installation.

Model	Pressure increase rate	Tank internal capacity L	Port size	Operating pressure MPa	Max. flow rate ℓ/min
MVBAT10	Twice	10	3/8	0.2~1	1000
MVBAT20	Twice	20	3/8	0.2~1	1000

MHBS / MHBD series [Single / Dual pressure type]

- Generates high pressure by use of high pressure hydraulic fluid.
- Universal design enables unit to be used in a wide variety of applications.
- Ideal for providing the motive force for marking, punching, shearing, straightening, embossing and welding.



Model	Type	Intensified pressure ratio	Discharging volume c.c.	Port size	Operating pressure	Generated hydraulic pressure
					MPa	MPa
MHBS-078	Single pressure type	7.8	50	3/8	0.2~0.7	5.3
MHBS-110		11	120	1/2	0.2~0.7	7.6
MHBS-250		25	120	1/2	0.2~0.7	17.2
MHBD-078	Dual pressure type	7.8	50	3/8	0.2~0.7	5.3
MHBD-110		11	120	1/2	0.2~0.7	7.6
MHBD-250		25	120	1/2	0.2~0.7	17.2

MEMO

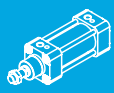

ISO Compliant



Space Saving



High Precision



High Rigidity



Longevity



Patent

Air Cylinder

- ISO cylinder** | Conforms to ISO 15552 specification enabling worldwide interchangeability.
- Mini cylinder** | Stainless steel cylinder tubes offer a high resistance to corrosion and low internal friction.
- Guide cylinder** | Higher loading capacity compared to unguided standard compact cylinders.
- Table** | The linear rails been heat treated and cryogenic finish, forming precisely grinding V-grooves. It is suitable for limited stroke linear motion system with high accuracy.
- Rodless cylinder** | 50% space saving when compared to conventional cylinders.
- Stopper cylinder** | Patented lever-lock mechanism. Adjustable shock absorber with easy replacement design.



Electronics Industry



New Energy Industry

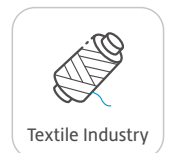

Textile Industry



Food Industry



Machinery Industry



Industry 4.0



MCQA series

- Special housing and bushing enables self lubrication of piston rod.
- Hard anodised aluminium cylinder tubes offer a high resistance to corrosion and low internal friction.
- Custom cylinders are available as are non standard strokes, rod extensions and special rod threads.
- Available with comprehensive internationally recognised range of fixed and flexible mountings.

Model	Style	Tube I.D.	Stroke	Operating pressure
		mm	mm	MPa
MCQA 11: Double acting / Male thread		40, 50, 63, 80, 100, 125, 150, 200	50~2500	0.05~1
MCQA 21: Double rod / Double acting		40, 50, 63, 80, 100, 125, 150, 200	50~2500	0.05~1
MCQA 27: Double rod / Adjustable male thread		40, 50, 63, 80, 100, 125, 150, 200	50~2500	0.05~1



MCQA-AH series [Air/ oil converter]

- Displacement is suggested about 50% of total volume
- Max. oil ascending speed is about 200mm/sec
- Oil is feeded not exceeding 80% of total volume.
- Unit should be installed vertically above the cylinder / actuator.

Model	Tube I.D.	Operating pressure	Proof pressure	Medium
	mm	MPa	MPa	
MCQA-AH	40, 50, 63, 80, 100, 125, 150	0.05~1	1.5	ISO VG32 equivalent



MCQN series [Inch]

- Special housing and bushing enables self lubrication of piston rod.
- Hard anodised aluminium cylinder tubes offer a high resistance to corrosion and low internal friction.
- Full range of NFPA interchangeable mounting configurations.

Model	Style	Tube I.D.	Stroke	Operating pressure
		inch	inch	MPa
MCQN 11: Double acting / Male thread		1 1/2, 2, 2 1/2, 3 1/4, 4	1~100	0.05~1



MCQV series [ISO 15552]

- Special housing and bushing enables self lubrication of piston rod.
- Hard anodised aluminium cylinder tubes offer a high resistance to corrosion and low internal friction.
- Conforms to ISO 15552 specification enabling worldwide interchangeability.
- Available with comprehensive internationally recognised range of fixed and flexible mountings.

Model	Style	Tube I.D.	Stroke	Operating pressure
		mm	mm	MPa
MCQV 11: Double acting / Male thread		125, 150, 200	50~2000	0.05~1
MCQV 21: Double rod / Double acting		125, 150, 200	50~2000	0.05~1
MCQV 27: Double rod / Adjustable male thread		125, 150, 200	50~2000	0.05~1

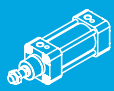

MCQV3 series [ISO 15552] [Automatic air cushioning]

- Pneumatic cushioning at both ends without adjusting.
- Special housing and bushing enable self lubrication of piston rod.
- Hard anodised aluminium cylinder tubes offer high resistance to corrosion and low internal friction.
- Conforms to ISO 15552 specification enabling worldwide.
- Available with comprehensive internationally recognised range of fixed and flexible mountings.

Model	Style	Tube I.D. mm	Stroke mm	Operating pressure MPa
MCQV3 11: Double acting / Male thread		32, 40, 50, 63, 80, 100	50~2500	0.05~1
MCQV3 21: Double rod / Double acting		32, 40, 50, 63, 80, 100	50~2500	0.05~1
MCQV3 27: Double rod / Adjustable male thread		32, 40, 50, 63, 80, 100	50~2500	0.05~1



MCQVS series [ISO 15552] [Stainless steel]

- AISI 316 stainless steel, fit the chemical, food and pharmaceutical environment.
- Conform to ISO 15552 specification, enabling worldwide interchangeability.
- Available with comprehensive internationally recognised range of fixed and flexible mountings.

Model	Style	Tube I.D. mm	Stroke mm	Operating pressure MPa
MCQVS 11: Double acting / Male thread		32, 40, 50, 63, 80, 100	25~1000	0.1~1
MCQVS 21: Double rod / Double acting		32, 40, 50, 63, 80, 100	25~1000	0.1~1
MCQVS 27: Double rod / Adjustable male thread		32, 40, 50, 63, 80, 100	25~1000	0.1~1



MCQV3L series [ISO 15552] [End lock]

- Special housing and bushing enables self lubrication of piston rod.
- Hard anodised aluminium cylinder tubes offer a high resistance to corrosion and low internal friction.
- Conforms to ISO 15552 specification enabling worldwide interchangeability.
- Available with comprehensive internationally recognised range of fixed and flexible mountings.

Model	Style	Tube I.D. mm	Stroke mm	Operating pressure MPa
MCQV3L 11: Double acting / Male thread (Rod cover)		63, 80	50~600	0.15~1
MCQV3L 11: Double acting / Male thread (Head cover)		63, 80	50~600	0.15~1



MCQI3 series [ISO 15552] [Automatic air cushioning]

- Pneumatic cushioning at both ends without adjusting.
- Special housing and bushing enable self lubrication of piston rod.
- Hard anodised aluminium cylinder tubes offer high resistance to corrosion and low internal friction.
- Conforms to ISO 15552 specification enabling worldwide.
- With four grooves on the tube, proximity and reed sensors can be easily inserted into any position.

Model	Style	Tube I.D. mm	Stroke mm	Operating pressure MPa
MCQI3 11: Double acting / Male thread		32, 40, 50, 63, 80, 100	50~2500	0.05~1
MCQI3 21: Double rod / Double acting		32, 40, 50, 63, 80, 100	50~2500	0.05~1
MCQI3 27: Double rod / Adjustable male thread		32, 40, 50, 63, 80, 100	50~2500	0.05~1



MCB* series [Rod locking cylinder]

- Brake function is applicable in both directions.
- No lubricant is required for the piston rod. Utilize oil-containing alloys and special bearing bush to eliminate the necessity of lubrication on piston rod.
- Hard anodized aluminum tube and stainless steel tube allows cylinder to have better corrosion and abrasion resistance.
- Conform to ISO 15552 standards. Unified design, most parts and mounting accessories are interchangeable.
- Available with a comprehensive selection of mountings for fixed or flexible installation.

Model	Style	Tube I.D.	Stroke	Operating pressure	Rod locking	
		mm	mm	MPa	Working pressure MPa	Retention forces N
MCBMI	11: Double acting / Male thread	20, 25	10~800	0.3~0.6	min. 0.3	490
MCBQ13	11: Double acting / Male thread	32, 40, 50, 63, 80, 100	50~2300	0.3~0.6	min. 0.3	7700
MCBQV3	11: Double acting / Male thread	32, 40, 50, 63, 80, 100	50~2300	0.3~0.6	min. 0.3	7700
MCBQV	11: Double acting / Male thread	125	50~1800	0.3~0.6	min. 0.3	12040

MCB series [Locking unit]



- Locking unit is a mechanical device to apply to cylinders ISO 15552 and ISO 6432 whose scope is to block cylinder's rod in any position. This solution allows to block the race of the cylinder anytime takes place an unexpected fall of pressure.
- The blocking force is always and however greater of the one developed from the respective cylinder at 1 MPa.

Model	Tube I.D.	Rod diameter	Operating pressure	Rod locking	
	mm	mm	MPa	Working pressure MPa	Retention forces N
MCB	20~125	8~32	0.3~0.6	min. 0.3	490~12040

Power Cylinder



MHPD series

- Hydro-pneumatic solution provides high power in confined space.
- Simple construction make these units ideal in many applications where previously hydraulics were the only option.
- Quiet in operation.
- Only requires a pneumatic valve to make the system operate.
- Wide range of working strokes and output forces available.

Model - Pressure boost	Tube I.D.	Total stroke	Working stroke	Operating pressure	Medium
	mm	mm	mm	MPa	
MHPD-1T	50	50, 75, 100, 150, 200	5, 10, 15, 20	0.3~0.8	Filtered air with or without lubrication
MHPD-3T	70	50, 75, 100, 150, 200	5, 10, 15, 20	0.3~0.8	
MHPD-5T	80	50, 75, 100, 150, 200	5, 10, 15, 20	0.3~0.8	
MHPD-8T	100	50, 75, 100, 150, 200	5, 10, 15, 20	0.3~0.8	
MHPD-10T	125	50, 75, 100, 150, 200	5, 10, 15, 20	0.3~0.8	

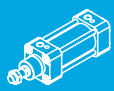

MCJA series

- Ultra Compact, light weight and space saving cylinder.
- Wide range of bore sizes and strokes (12mm~100mm).
- Single and double acting available.
- Ideal for use in machinery where space is limited and incorporating sensor groove which enables flush fitting of sensors.

Model	Style	Tube I.D.	Stroke	Operating pressure
		mm	mm	MPa
MCJA 11: Single rod / Double acting		12, 16, 20, 25, 32, 40, 50, 63, 80, 100	5~300	0.02~1
MCJA 12: Double acting / Female thread		12, 16, 20, 25, 32, 40, 50, 63, 80, 100	5~300	0.02~1
MCJA 13: Single acting / Normally extended male thread		12, 16, 20, 25, 32, 40, 50	5~300	0.1~1
MCJA 14: Single acting / Normally extended female thread		12, 16, 20, 25, 32, 40, 50	5~300	0.1~1
MCJA 15: Single acting / Normally returned male thread		12, 16, 20, 25, 32, 40, 50	5~300	0.1~1
MCJA 16: Single acting / Normally returned female thread		12, 16, 20, 25, 32, 40, 50	5~300	0.1~1
MCJA 21: Double rod / Double acting		12, 16, 20, 25, 32, 40, 50, 63, 80, 100	5~300	0.02~1
MCJA 22: Double rod / Female thread		12, 16, 20, 25, 32, 40, 50, 63, 80, 100	5~300	0.02~1
MCJA 23: Single acting / Double rod / Male thread		12, 16, 20, 25, 32, 40, 50, 63, 80, 100	5~300	0.1~1
MCJA 24: Single acting / Double rod / Female thread		12, 16, 20, 25, 32, 40, 50, 63, 80, 100	5~300	0.1~1
MCJA 27: Double rod / Adjustable male thread		12, 16, 20, 25, 32, 40, 50, 63, 80, 100	5~300	0.02~1



MCJA-3 series [Multiple position]

Model	Style	Tube I.D.	Max. stroke		Operating pressure
		mm	First	Total	MPa
MCJA 31: Double acting / Male thread		12, 16, 20, 25, 32, 40, 50, 63, 80, 100	5~130	300	0.02~1
MCJA 32: Double acting / Female thread		12, 16, 20, 25, 32, 40, 50, 63, 80, 100	5~130	300	0.02~1
MCJA 35: Single acting / Normally returned male thread		12, 16, 20, 25, 32, 40, 50	5~30	30	0.1~1
MCJA 36: Single acting / Normally returned female thread		12, 16, 20, 25, 32, 40, 50	5~30	30	0.1~1



MCJA-4 series [Back to back type]

Model	Style	Tube I.D.	Max. stroke		Operating pressure
		mm	First	Second	MPa
MCJA 41: Double acting / Male thread		12, 16, 20, 25, 32, 40, 50, 63, 80, 100	5~130	300	0.02~1
MCJA 42: Double acting / Female thread		12, 16, 20, 25, 32, 40, 50, 63, 80, 100	5~130	300	0.02~1
MCJA 43: Single acting / Normally extended male thread		12, 16, 20, 25, 32, 40, 50	5~30	30	0.1~1
MCJA 44: Single acting / Normally extended female thread		12, 16, 20, 25, 32, 40, 50	5~30	30	0.1~1
MCJA 45: Single acting / Normally returned male thread		12, 16, 20, 25, 32, 40, 50	5~30	30	0.1~1
MCJA 46: Single acting / Normally returned female thread		12, 16, 20, 25, 32, 40, 50	5~30	30	0.1~1



MCJQ series

- Ultra compact, light weight and space saving cylinder.
- Wide range of bore sizes and strokes (12mm~100mm).
- Single and double acting available.
- Ideal for use in machinery where space is limited and incorporating sensor groove which enables flush fitting of sensors.
- Sensor can be mounted on any one of three faces on 12 and 16 bore and on four faces on 20~100 bore.

Model	Style	Tube I.D. mm	Stroke mm	Operating pressure MPa
MCJQ 11: Double acting / Male thread		12, 16, 20, 25, 32, 40, 50, 63, 80, 100	5~300	0.05~1
MCJQ 12: Double acting / Female thread		12, 16, 20, 25, 32, 40, 50, 63, 80, 100	5~300	0.05~1
MCJQ 13: Single acting / Normally extended male thread		12, 16, 20, 25, 32, 40, 50	5~20	0.1~1
MCJQ 14: Single acting / Normally extended female thread		12, 16, 20, 25, 32, 40, 50	5~20	0.1~1
MCJQ 15: Single acting / Normally returned male thread		12, 16, 20, 25, 32, 40, 50	5~20	0.1~1
MCJQ 16: Single acting / Normally returned female thread		12, 16, 20, 25, 32, 40, 50	5~20	0.1~1
MCJQ 21: Double rod / Male thread		12, 16, 20, 25, 32, 40, 50, 63, 80, 100	5~300	0.05~1
MCJQ 22: Double rod / Female thread		12, 16, 20, 25, 32, 40, 50, 63, 80, 100	5~300	0.05~1
MCJQ 23: Single acting / Double rod / Male thread		12, 16, 20, 25, 32, 40, 50, 63, 80, 100	5~20	0.1~1
MCJQ 24: Single acting / Double rod / Female thread		12, 16, 20, 25, 32, 40, 50, 63, 80, 100	5~20	0.1~1
MCJQ 27: Double rod / Adjustable male thread		12, 16, 20, 25, 32, 40, 50, 63, 80, 100	5~300	0.05~1
MCJQ 28: Double rod / Adjustable female thread		12, 16, 20, 25, 32, 40, 50, 63, 80, 100	5~300	0.05~1



MCKJQ series [Non-rotation]

- Hexagonal rods for Non-rotation feature. Stainless Steel rods for higher corrosion resistance.
- The profile designs are based on MCJQ.
- Anodised aluminum tubes provide better corrosion and abrasion resistance.

Model	Style	Tube I.D. mm	Stroke mm	Operating pressure MPa	Rod non-rotation accuracy °	Allowable rotational torque kgf · cm
MCKJQ 11: Double acting / Male thread		12, 16, 20, 25, 32, 40	5~100	0.1~1	±0.5~±1	0.4~4.5
MCKJQ 12: Double acting / Female thread		12, 16, 20, 25, 32, 40	5~100	0.1~1	±0.5~±1	0.4~4.5



MCJQ2 series

- Ultra Compact, light weight and space saving cylinder.
- Single and double acting available.
- Ideal for use in machinery where space is limited and incorporating sensor groove which enables flush fitting of sensors.

Model	Style	Tube I.D. mm	Stroke mm	Operating pressure MPa
MCJQ2 11: Double acting / Male thread		12, 16, 20, 25	5~50	0.05~1
MCJQ2 12: Double acting / Female thread		12, 16, 20, 25	5~50	0.05~1



MCJQ-3 series [Multiple position]

- Two-stage stroke: Two compact cylinders with same I.D. but different strokes length are connected to achieve two-stage stroke.

Model	Style	Tube I.D. mm	Max. stroke mm	Operating pressure MPa	
			First	Total	
MCJQ 31: Double acting / Male thread		12, 16, 20, 25, 32, 40, 50, 63, 80, 100	5~100	300	0.05~1
MCJQ 32: Double acting / Female thread		12, 16, 20, 25, 32, 40, 50, 63, 80, 100	5~100	300	0.05~1

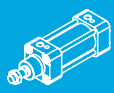

MCJI series [ISO 21287]

- Wide range of bore sizes and strokes. Ultra compact, light weight and space saving.
- Sensor slots on RCI sides for flush mounting of proximity sensors. Standard with magnet.

Model	Style	Tube I.D. mm	Stroke mm	Operating pressure MPa
MCJI 11	Double acting / Male thread	25, 32, 40, 50, 63, 80, 100	5~500	0.05~1
MCJI 12	Double acting / Female thread	25, 32, 40, 50, 63, 80, 100	5~500	0.05~1
MCJI 21	Double rod / Double acting	25, 32, 40, 50, 63, 80, 100	5~500	0.05~1
MCJI 22	Double rod / Female thread	25, 32, 40, 50, 63, 80, 100	5~500	0.05~1



MCJI-3 series [Multiple position]

Model	Style	Tube I.D. mm	Max. stroke mm		Operating pressure MPa
			First	Total	
MCJI 31	Double acting / Male thread	20, 25, 32, 40, 50, 63, 80, 100	5~150	500	0.05~1
MCJI 32	Double acting / Female thread	20, 25, 32, 40, 50, 63, 80, 100	5~150	500	0.05~1



MCJU series [Plate oval] [Non-rotation]

- Plate type design for ultra compact, Oval piston design for non-rotation and space saving.
- Sensor slots on sides for flush mounting of proximity sensors.
- Standard with magnet.

Model	Style	Tube I.D. mm	Stroke mm	Operating pressure MPa
MCJU 11	Double acting / Male thread	25, 32, 40, 50, 63	5~300	0.05~0.7
MCJU 12	Double acting / Female thread	25, 32, 40, 50, 63	5~300	0.05~0.7
MCJU 21	Double rod / Double acting	25, 32, 40, 50, 63	5~300	0.05~0.7
MCJU 22	Double rod / Female thread	25, 32, 40, 50, 63	5~300	0.05~0.7

Multi-Mount Cylinder



MCFA series

- Compact and space saving.

Model	Style	Tube I.D. mm	Stroke mm	Operating pressure MPa
MCFA 11	Double acting / Male thread	6, 10, 16, 20, 25, 32	5~50	0.05~0.7
MCFA 21	Double rod / Double acting	6, 10, 16, 20, 25, 32	5~50	0.05~0.7



MCFB series

- Compact and space saving.
- Flush fitting sensor.

Model	Style	Tube I.D. mm	Stroke mm	Operating pressure MPa
MCFB 11	Double acting / Male thread	6, 8, 10, 16, 20	4~50	0.05~0.7
MCFB 21	Double rod / Double acting	6, 8, 10, 16, 20	4~50	0.05~0.7
MCFB 15	Single acting / Normally returned male thread	6, 8, 10	4~10	0.2~0.7
MCFB 16	Single acting / Normally returned female thread	6, 8, 10	4~10	0.2~0.7



MCMA series

- Special housing and bushing enable self lubrication of piston rod.
- Hard anodised stainless steel cylinder tubes offer a high resistance to corrosion and low internal friction.
- Cylinder mountings, available with a comprehensive range of accessories for rigid or flexible mounting.

Model	Style	Tube I.D. mm	Stroke mm	Operating pressure MPa
MCMA 11	Double acting / Male thread	16, 20, 25, 32, 40	15~500	0.06~0.7
MCMA 13	Single acting / Normally extended male thread	16, 20, 25, 32, 40	15~150	0.15~0.7
MCMA 15	Single acting / Normally returned male thread	16, 20, 25, 32, 40	15~150	0.15~0.7
MCMA 21	Double rod / Double acting	16, 20, 25, 32, 40	15~500	0.06~0.7
MCMA 23	Single acting / Double rod male thread	16, 20, 25, 32, 40	15~150	0.15~0.7
MCMA 27	Double rod / Adjustable male thread	16, 20, 25, 32, 40	15~500	0.06~0.7



MCMB series

- Special housing and bushing enables self lubrication of piston rod.
- Hard anodised stainless steel cylinder tubes offer a high resistance to corrosion and low internal friction.
- Cylinder mountings, available with a comprehensive range of accessories for rigid or flexible mounting.

Model	Style	Tube I.D. mm	Stroke mm	Operating pressure MPa
MCMB 11	Double acting / Male thread	20, 25, 32, 40	25~300	0.05~1
MCMB 13	Single acting / Normally extended male thread	20, 25, 32, 40	25~300	0.23~1
MCMB 15	Single acting / Normally returned male thread	20, 25, 32, 40	25~300	0.18~1
MCMB 21	Double rod / Double acting	20, 25, 32, 40	25~300	0.05~1
MCMB 27	Double rod / Adjustable male thread	20, 25, 32, 40	25~300	0.05~1



MCKMB series [Non-rotation]

- Cylinder with hexagonal rod design enables non-rotation of rod.
- Special housing and bushing enables self lubrication of piston rod.
- Hard anodised stainless steel cylinder tubes offer a high resistance to corrosion and low internal friction.
- Cylinder mountings, available with a comprehensive range of accessories for rigid or flexible mounting.

Model	Style	Tube I.D. mm	Stroke mm	Operating pressure MPa
MCKMB 11	Double acting / Male thread	20, 25, 32, 40	25~300	0.05~0.7



MCMBL series [End lock]

- Cylinder remains same position when it reaches end of stroke even if the input air source is gone.
- Self-lubricating bush provides longer service life.
- Stainless steel cylinder tubes for better corrosion resistance.
- Cylinder mountings, available with a comprehensive range of accessories for rigid or flexible mounting.

Model	Style	Tube I.D. mm	Stroke mm	Operating pressure MPa
MCMBL 11	Double acting / Male thread	32, 40	25~300	0.15~1

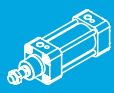

Mini Cylinder



MCMBR series

- The cylinder can be directly mounted without bracket, the overall length is greatly shortened. This gives the benefit of saving space when installing the cylinder.
- Increased strength and accuracy of installation.
- Cylinder can be front mounted or bottom mounted.

Model	Mounting	Style	Tube I.D. mm	Stroke mm	Operating pressure MPa
MCMBRA	Bottom mounting	11: Double acting / Male thread	20, 25, 32, 40	25~300	0.05~1
MCMBRB	Front mounting	11: Double acting / Male thread	20, 25, 32, 40	25~300	0.05~1



MCMI series [ISO 6432]

- Special housing and bushing enables self lubrication of piston rod.
- Hard anodised stainless steel cylinder tubes offer a high resistance to corrosion and low internal friction.
- ISO 6432 standard (ø8~ø25). Enables world-wide inter-changeability.
- Available with a comprehensive range of accessories for rigid or flexible mounting.

Model	Style	Tube I.D. mm	Stroke mm	Operating pressure MPa
MCMI 11:	Double acting / Male thread	8, 10, 12, 16, 20, 25, 32, 40	10~1000	0.06~0.7
MCMI 13:	Single acting / Normally extended male thread	16, 20, 25	15~150	0.23~0.7
MCMI 15:	Single acting / Normally returned male thread	16, 20, 25	15~150	0.18~0.7
MCMI 21:	Double rod / Male thread	16, 20, 25, 32, 40	15~450	0.06~0.7
MCMI 27:	Double rod / Adjustable male thread	16, 20, 25, 32, 40	15~450	0.06~0.7



MCMIS series [ISO 6432 Stainless steel]

- Special housing and bushing enables self lubrication of piston rod.
- Highly resistant with crimped covers and entirely built in stainless steel. Available with or without adjustable cushioning, double acting or through piston rod. On request compliant with 2014/34/UE ATEX directive.
- ISO 6432 standard. Enables world-wide inter-changeability.
- Available with a comprehensive range of accessories for rigid or flexible mounting.

Model	Style	Tube I.D. mm	Stroke mm	Operating pressure MPa
MCMIS 11:	Double acting / Male thread	10, 12, 16, 20, 25	10~500	0.08~1
MCMIS 21:	Double rod / Male thread	10, 12, 16, 20, 25	10~500	0.08~1

Pen Cylinder



MCMJ series

- Stainless steel cylinder tubes offer a high resistance to corrosion and low internal friction.
- Available with a comprehensive range of accessories for rigid or flexible mounting.

Model	Style	Tube I.D. mm	Stroke mm	Operating pressure MPa
MCMJ 11:	Double acting / Male thread	6, 10, 16	15~200	0.06~0.7
MCMJ 13:	Single acting / Normally extended male thread	6, 10, 16	15~150	0.15~0.7
MCMJ 15:	Single acting / Normally returned male thread	6, 10, 16	15~150	0.15~0.7



MCMJ1 series

Model	Style	Tube I.D. mm	Stroke mm	Operating pressure MPa
MCMJ1	15: Single acting / Normally returned male thread	4	5-20	0.3-0.7



MCMJP series

- Space saving, compact design enables simple mounting.
- Flush fitting sensor switch.

Model	Style	Tube I.D. mm	Stroke mm	Operating pressure MPa
MCMJP	11: Double acting / Male thread	6, 10, 16	5-40	0.06-0.7
MCMJP	18: Double acting / Threadless	6, 10, 16	5-40	0.06-0.7



MCMJP* series

- A short stroke miniature cylinder with a shorter overall length.

Model	Mounting	Style	Tube I.D. mm	Stroke mm	Operating pressure MPa
MCMJPB	Panel mounting	10: Single acting / Normally returned without thread	6, 10, 15	5, 10, 15	0.15-0.7
MCMJPS	Plug mounting	15: Single acting / Normally returned male thread	6, 10, 15	5, 10, 15	0.15-0.7

Round Cylinder



MCCG series [mm]

Model	Style	Tube I.D. mm	Stroke mm	Operating pressure MPa
MCCG	11: Double acting / Male thread	20, 25, 32, 40, 50, 63, 80, 100	25-1200	0.05-1



MCCN series [inch]

Model	Style	Tube I.D. inch	Stroke inch	Operating pressure MPa
MCCN	11: Double acting / Male thread	3/4, 1, 1 1/4, 1 1/2, 2, 2 1/2	1-48	0.05-1

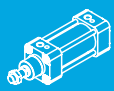

MCCH series

- The diameter of the port orifice has been enlarged to support high speed operation. max speed: 3000mm/sec.
- Longer cushion rod to absorb more exercise energy and reduce external cushioning settings.
- The cylinder with relief valve provides better cushioning performance than the general purpose cylinder with needle valve.
- The relief valve body can rotate 360 degrees freely, which is convenient for adjustment and use.

Model	Style	Tube I.D. mm	Stroke mm	Operating pressure MPa
MCCH	11: Double acting / Male thread	25, 32	250~1500	0.05~1

Twin-Guide Cylinder



MCGA series [Stop type / Lift type]

- Strong cylinder capable of high loads, used extensively for stopping work carriers in both the vertical and horizontal position.
- Large diameter guide rods enable cylinder to take high off-set loads.
- Can be used as 90 degree pusher on large conveyor systems.

Model	Purpose / type of bearing	Tube I.D. mm	Stroke mm	Operating pressure MPa
MCGA	03 : Stop / Slide bush	20, 32, 40, 50, 63, 80	30~100	0.1~1
MCGA	13 : Lift / Linear bearing	20, 32, 40, 50, 63, 80	30~100	0.1~1
MCGA	53 : Lift / Slide bush	20, 32, 40, 50, 63, 80	30~100	0.1~1



MCGA series [Push type]

- Long stroke type of the anti-turn accuracy, improved by integrating the guides and cylinder.
- Linear bush bearing type available for high accuracy in the high speed work. On the link bar at the top, Many thread holes for mounting attachments are provided for easy mounting.
- Lift type of long stroke is available by replacing the link bar with table plate. Standard with magnet.

Model	Purpose / type of bearing	Tube I.D. mm	Stroke mm	Operating pressure MPa
MCGA	23: Push / Linear bearing	20, 32, 40, 50, 63, 80	30~700	0.1~1
MCGA	63: Push / Slide bush	20, 32, 40, 50, 63, 80	30~700	0.1~1



MCGB series

- Proven track record in manufacturing precision guided cylinders.
- Multi-Ports as standard enabling two direction mounting option.
- Flush fitting sensors.
- In built high density rubber pad absorbs energy at the end of stroke.

Model	Purpose / type of bearing	Tube I.D. mm	Stroke mm	Operating pressure MPa
MCGB	03: Stop / Slide bush	12, 16, 20, 25, 32	10~200	0.1~1
MCGB	23: Push / Linear bearing	12, 16, 20, 25, 32	10~200	0.1~1



MCGS series

- Multi-ports as standard enabling both direction mounting. Proven track record in manufacturing precision guided cylinders.
- Non-rotation accuracy $\pm 0.1^\circ$.
- Embedding type sensors.
- The sensor cable will be in the same direction as the piping tube if vertical type sensor switch (Angle cable) is used.

Model	Purpose / type of bearing	Tube I.D. mm	Stroke mm	Operating pressure MPa
MCGS	–	6, 10	5~20	0.15~0.7
MCGS 03:	Stop / Slide bush	12, 16, 20, 25, 32, 40, 50, 63	10~400	0.1~1
MCGS 07:	Stop / Slide bush / Stroke adjustable	12, 16, 20, 25, 32, 40, 50, 63	10~400	0.1~1
MCGS 23:	Push / Linear bearing	12, 16, 20, 25, 32, 40, 50, 63	10~400	0.1~1
MCGS 27:	Push / Linear bearing / Stroke adjustable	12, 16, 20, 25, 32, 40, 50, 63	10~400	0.1~1



MCGI series [Compact]

- Higher loading capacity compared to unguided standard compact cylinders.
- Wide range of bore sizes and strokes.
- Ultra compact, light weight and space saving.
- Sensor slots on RCI sides for flush mounting of proximity sensors.

Model	Purpose / type of bearing	Tube I.D. mm	Stroke mm	Operating pressure MPa
MCGI	12: Lift / Slide bush	20, 25, 32, 40, 50, 63, 80, 100	5~300	0.1~1



MCGM series [Compact]

- Higher loading capacity compared to unguided standard compact cylinders.
- Up to 6 flush fitting reed switches can be mounted.

Model	Purpose / type of bearing	Tube I.D. mm	Stroke mm	Operating pressure MPa
MCGM	12: Lift / Slide bush	12, 16, 20, 25, 32, 40, 50, 63, 80, 100	5~100	0.1~1



MGT* series

- The guide rod cylinder is a combination of ISO 6432 / ISO 15552 cylinders with guide accessories. It has excellent resistance to rotation, torque and lateral load.
- Four self-lubricating bushes or linear bearings enable high loading and precise movement.
- Simplified structure, save a lot of time when designing mechanism/application, generating new drawing and installing.
- The MGT* have longer stroke and a larger bore size than the MCG* cylinder.
- $\phi 32\sim\phi 63$ With four grooves on the tube, reed sensors can be easily inserted into any position.
- Adjustable cushion as standard.

Model	Purpose / type of bearing	Tube I.D. mm	Stroke mm	Operating pressure MPa
MGTK	Light duty type	20, 25	15~500	0.2~0.7
MGTX	Light duty flange type	32, 40, 50, 63	50~1500	0.2~0.7
MGTB	Heavy duty (bush) type	20, 25, 32, 40, 50, 63	50~1500	0.2~0.7
MGTU	Heavy duty (linear bearing) type	20, 25, 32, 40, 50, 63	50~1500	0.2~0.7

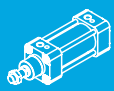

MCGD series [Twin-guide]

- Can be used as plate slide type or body slide type.
- The air cylinder and guide share a compact design which enables the cylinder to work smoothly along its stroke.
- The cylinder is extremely rigid and strong. Flush fitting sensor available.

Model	Type of bearing	Tube I.D. mm	Stroke mm	Operating pressure MPa
MCGD	03: Slide bush	12, 16, 20, 25, 32	30~250	0.1~1
MCGD	23: Linear bearing	12, 16, 20, 25, 32	30~250	0.1~1



MCG3 series [Triple-guide]

- Three guide rods equally spaced enable consistent movement even when uneven load is applied.
- Increases productivity on conveyor lines.
- When connected to a rotary actuator the unit can be used as an auto turn lifter.

Model	Purpose / Type of bearing	Tube I.D. mm	Stroke mm	Operating pressure MPa
MCG3	D: Circle table lift / Slide bush	63, 80	30, 50, 75, 100	0.1~1
MCG3	B: Circle table lift / Linear bearing	63, 80	30, 50, 75, 100	0.1~1
MCG3	D90: Turntable / Angle 90° / Slide bush	63	30, 50, 75, 100	0.1~1
MCG3	B90: Turntable / Angle 90° / Linear bearing	63	30, 50, 75, 100	0.1~1
MCG3	D180: Turntable / Angle 180° / Slide bush	63	30, 50, 75, 100	0.1~1
MCG3	B180: Turntable / Angle 180° / Linear bearing	63	30, 50, 75, 100	0.1~1
MCG3	QD: Quad table lift / Slide bush	63	30, 50, 75, 100	0.1~1
MCG3	QB: Quad table lift / Linear bearing	63	30, 50, 75, 100	0.1~1



MCDA series [Dual-rod cylinder]

- Compact in width and length with precision guidance.
- High lateral loads can be applied on both slide and linear bearing unit.
- Non rotation is standard.

Model	Type of bearing	Tube I.D. mm	Stroke mm	Operating pressure MPa
MCDA	03: Slide bush	6, 12, 16, 20, 25, 32	10~200	0.05~0.7
MCDA	23: Linear bearing	6, 12, 16, 20, 25, 32	10~200	0.05~0.7



MCDJ series [Dual-rod cylinder]

- Compact in width and length with precision guidance.
- High lateral loads can be applied on both slide and linear bearing unit.

Model	Type of bearing	Tube I.D. mm	Stroke mm	Operating pressure MPa
MCDJ	03: Slide bush	6, 10	10~50	0.1~0.7



MCSS series

- High precision combination of cylinder and linear rail.
- Flush fitting sensor groove.
- Provide optional combination for stroke adjuster and end lock (for vertical installation to prevent falling).

Model	Acting type	Tube I.D. mm	Stroke mm	Operating pressure MPa	Cushion
MCSS	Double acting	6, 8, 12, 16, 20, 25	10~150	0.15~0.7	Rubber bumper, Shock absorber



MCSQ series

- High precision combination of cylinder and linear rail.
- Flush fitting sensor groove.

Model	Acting type	Tube I.D. mm	Stroke mm	Operating pressure MPa	Cushion
MCSQ	Double acting	6, 8	10~75	0.15~0.7	Rubber bumper, Shock absorber



MCSF series [Low profile]

- $\phi 5.2$: The thickness is 6.5mm, achieving the slim compact.
- Built-in guide for accurate motion. Flush fitting sensor groove.

Model	Acting type	Tube I.D. mm	Stroke mm	Operating pressure MPa	Cushion
MCSF	Double acting	5.2	10	0.2~0.7	Cushion spring
MCSF	Double acting	8, 12, 16, 20	10~100	0.15~0.7	Rubber bumper



MCSH series [Compact]

- Compact precision cylinder.
- Cylinder can take high lateral loads and is also non rotating.
- Cylinder can be mounted in 3 or 4 positions.

Model	Acting type	Tube I.D. mm	Stroke mm	Operating pressure MPa	Cushion
MCSH	Double acting	6, 10, 16, 20	5~60	0.05~0.7	Rubber bumper

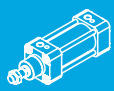

MCRPL(F) series

- Double acting
- \varnothing 16, 25, 32, 40, 50, 63 mm
- Operating pressure: 0.1–0.78 MPa
- Stroke: 100–5600 mm
- Cushion: With adjustable cushion at both ends



MCRPLK series

- Double acting
- \varnothing 16, 25, 32, 40 mm
- Operating pressure: 0.1–0.78 MPa
- Stroke: 100–3600 mm
- Cushion: With adjustable cushion at both ends



MCRPLS series

- Double acting
- \varnothing 32, 40, 50, 63 mm
- Operating pressure: 0.05–0.8 MPa
- Stroke: 100–2000 mm
- Cushion: With adjustable cushion at both ends

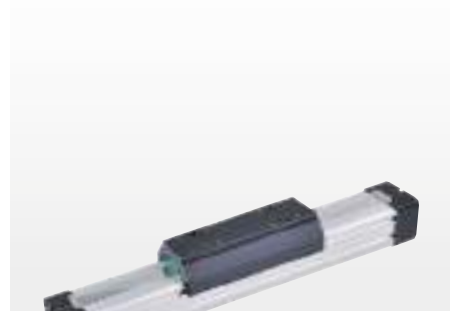

MCRPMM series

[Magnetically coupled]

- Double acting
- \varnothing 10, 15, 20, 25, 32, 40 mm
- Operating pressure: 0.18–0.7 MPa
- Stroke: 100–2000 mm
- Holding force: 53.9–922 N



MCRPMD series

[Magnetically coupled]

- Double acting
- \varnothing 10, 15, 20, 25, 32 mm
- Operating pressure: 0.18–0.7 MPa
- Stroke: 100–2000 mm
- Holding force: 53.9–588 N



MCRPMS series

[Magnetically coupled]

- Double acting
- \varnothing 10, 15, 20, 25, 32 mm
- Operating pressure: 0.2–0.7 MPa
- Stroke: 50–1500 mm
- Holding force: 53.9–588 N



MSBE series

- Double acting
- $\varnothing 32, 50, 63, 80$ mm
- Operating pressure: 0.2~1 MPa
- Stroke: 20, 30, 40 mm
- Adjustable shock absorber+NBR cushion pad

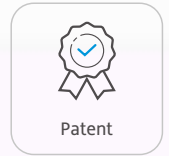
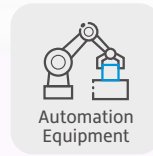

Air Cylinder

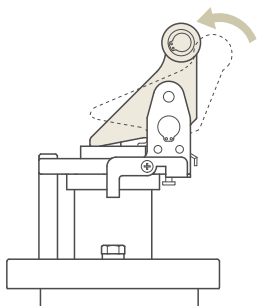

Lock Mechanism

Lock mechanism prevents the light-weight workpiece from moving back by the force of shock absorber after damping.

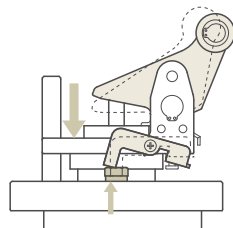

Pneumatic Unlock Lock Mechanism

The locking / deactivation mechanism of MSBE*-L* can be unlocked / reactivated by return the piston rod.

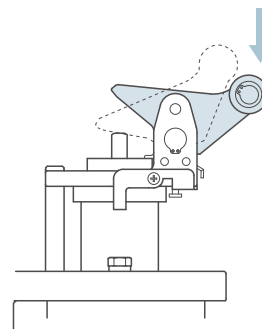

Deactivation Mechanism

Deactivation mechanism can deactivate the cylinder without any disassembling.

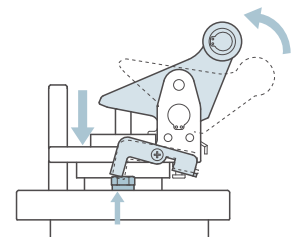

Pneumatic Unlock Deactivation Mechanism

The mechanism can be unlocked / reactivated by return the piston rod. Replace traditional manual unlock, which is suitable for fully automated production lines. [for $\varnothing 50, \varnothing 63, \varnothing 80$]

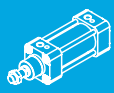

**MSBR series**

Model	Operation type	Acting type	Tube I.D. - Stroke mm	Operating pressure MPa
MSBR	Stopper with roller	Double acting	20-20	0.2~1
MSBR	Stopper with roller	Single acting (Spring extended)	32-20, 40-30, 50-30	0.2~1

**MSBS series**

Model	Operation type	Acting type	Tube I.D. - Stroke mm	Operating pressure MPa
MSBS	Direct stopper	Double acting	20-10, 32-20, 50-30	0.2~1

**MSAR series**

Model	Operation type	Acting type	Tube I.D. - Stroke mm	Operating pressure MPa
MSAR	Stopper with roller	Single acting (Spring extended)	32-20, 50-30, 80-30	0.2~1

**MSLP series**

Model	Acting type	Tube I.D. - Stroke mm	Operating pressure MPa
MSLP-P	Double acting Extend type	32-40	0.2~1
MSLP-CP	Double acting Return type	32-40	0.2~1

**MSLL series**

Model	Acting type	Tube I.D. - Stroke mm	Operating pressure MPa
MSLL	Double acting with spring	25-30, 40-30	0.2~1
MSLL-D	Double acting without spring	25-30, 40-30	0.2~1

**MSLD series**

Model	Acting type	Tube I.D. - Stroke mm	Operating pressure MPa
MSLD	Double acting with spring and shock absorber	50-50	0.2~1

M CRA series

- Double acting
- $\phi 63$ mm
- Operating pressure: 0.1~1 MPa
- Rotary angle: 90, 180°
- Allowable kinetic energy: 1.5 J
- Air cushion



M CRB series

- Double acting
- $\phi 16, 20, 25, 32$ mm
- Operating pressure: 0.1~1 MPa
- Rotary angle: 0~190°
- Allowable kinetic energy: 0.007~1.6 J
- NBR spacer, shock absorber



M CRC series

[Vane mechanism]

- Double acting
- Size: 30
- Operating pressure: 0.15~1 MPa
- Rotary angle: 90, 180, 270°
- Allowable kinetic energy: 0.02 J



M CRQ series

- Double acting
- $\phi 12, 16, 20, 25, 32, 40$ mm
- Operating pressure: 0.1~1 MPa
- Rotary angle: 0~190°
- Allowable kinetic energy: 0.006~2.9 J
- Rubber bumper, Shock absorber



M CRQ-S series

- Double acting
- $\phi 16, 20, 25$ mm
- Operating pressure: 0.2~1 MPa
- Rotary angle: 90, 180°
- Allowable kinetic energy: 0.23~1.82 J
- Shock absorber



M CRJ-S series [Mini]

- Double acting
- $\phi 6, 8$ mm
- Operating pressure: 0.15~0.7 MPa
- Rotary angle: 90, 180°
- Angle adjustment: Each rotation end $\pm 5^\circ$



- The body is manufactured in anodized aluminium alloy, and has been designed looking at the harmonious aesthetic development.
- Pinion and rack produced from carbon steel reduces backlash within the mechanism.

M RTH series

- Male pivot gear (standard type)
- Male pivot gear (double end rod type)
- $\phi 40, 63, 80$ mm
- Operating pressure: 0.13~0.7 MPa
- Rotary angle: 90, 180°
- Allowable kinetic energy: 0.26~3.03 J

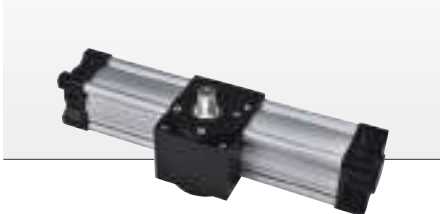

M RTF series

- Female pivot gear
- $\phi 40, 63, 80$ mm
- Operating pressure 0.13~0.7 MPa
- Rotary angle: 90, 180°
- Allowable kinetic energy: 0.26~3.03 J

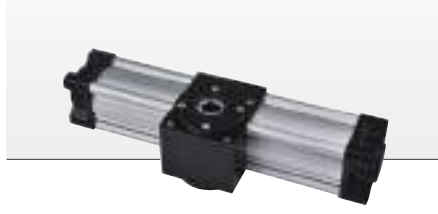

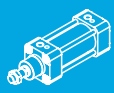

MCKC series [Pneumatic-swing]

- Built-in counterbore design for mounting without additional bracket.
- Easy to adjust sensor position.
- Selectable clamping lever.

Model	Acting type	Tube I.D.	Operating pressure MPa	Rotary angle °	Rotary direction
MCKC	Double acting	12, 16, 20, 25, 32, 40, 50	0.1~1	90±10	Left (L), Right (R)



MCKB series

- Lever type clamp cylinder gives high clamping force.
- Simple mounting of sensors on all four sides of body.
- Hard anodised body gives smooth lines and high corrosion resistance.

Model	Acting type	Tube I.D. - Stroke mm	Operating pressure MPa
MCKB	Double acting	25-20, 32-25, 40-25, 50-30, 63-35	0.1~1



MCKA series

- Aluminium alloy tube provides both smooth lines and high corrosion resistance.
- Self lubricated nose bush gives long life.
- Versatile porting position available.
- End cushioning at both ends reduces impact loads.

Model	Acting type	Tube I.D. mm	Stroke mm	Operating pressure MPa
MCKA	Double acting	40	50~150	0.05~1



MCKG series

- Aluminium alloy tube provides both smooth lines and high corrosion resistance.
- Self lubricated nose bush gives long life.
- Versatile porting position available.
- End cushioning at both ends reduces impact loads.
- Available with magnetic piston and sensors.

Model	Acting type	Tube I.D. mm	Stroke mm	Operating pressure MPa
MCKG	Double acting	50, 63	50~150	0.05~1



Strong Clamping



Space Saving



Multi Types of Arms



Multi-Angle



Anti-Interference Sensor



Self-Locking Mechanism

MCKD series [Powerful]

- Oval piston design for space saving.
- Clamping arm angle is adjustable via adjusting bolt.
- 12 types of clamping arm are available for different applications.
- 15° minimum release angle for lowering clamping time.
- Welding slag and magnetic field proof sensor available.
- Cylinder remains clamping position with self-locking mechanism even if there is no air input.

Model	Acting type	Tube I.D. mm	Release angle °	Operating pressure MPa
MCKD	Double acting	50, 63	15, 30, 45, 60, 75, 90, 105, 120, 135	0.3~0.8



Lightweight



High Grip



High Precision



High Rigidity



Longevity



Patent

End of Arm Tooling (EOAT)

Applications of advanced robot system become the crucial technology. Therefore, Mindman launched diversified lightweight grippers for different industries & application.

- Durability | Mindman has an ultra-high lifespan of 5,000,000 actuation test with excellent reliability.
- Diversity | Parallel, angle, rotation, all-in-one gripper and deburring tools, etc.
- Automatic Tool Changer | MCTC series, patented and won the 2022 Taiwan Excellence Award.



Electronics Industry

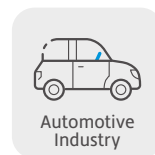

Automotive Industry

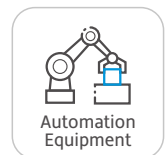

Automation Equipment



Food Industry



Machinery Industry



Industry 4.0

▶ Various Jaws are Available

● Standard



● Narrow



● Side tapped mounting



● Through hole



● Flat

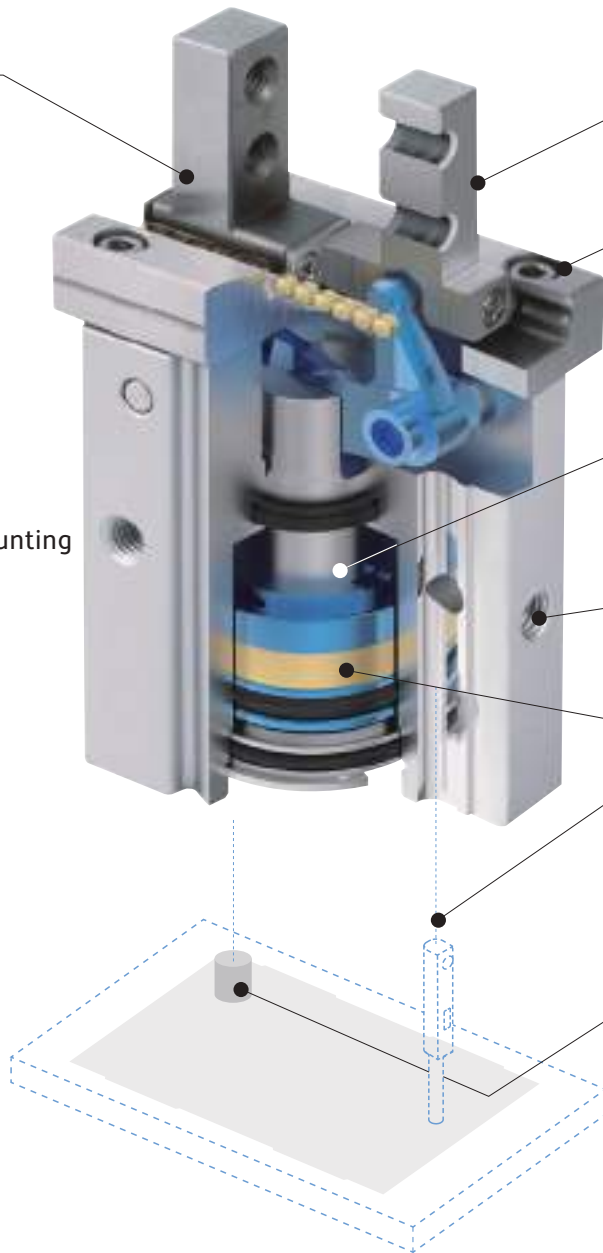

▶ Repeatability

±0.01 mm

▶ Stroke

Standard and long stroke.

[The stroke length for long stroke type is approximately double compare with standard type]

▶ Acting

Single / Double acting

[N.C. / N.O. (optional)]



▶ Mounting Position

Bottom / Side / Front



▶ Sensor Switch

RDE, RNE, RPE series

[Standard with magnet Embedded sensor design]

▶ Positioning Holes

With positioning holes for fast positioning when changing grippers.

End of Arm Tooling

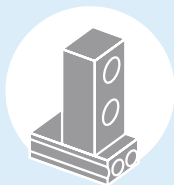

7 kinds of mounting jaw available

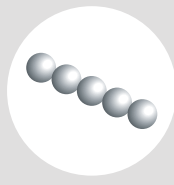

Linear ball bearing guide for high rigidity and precision



Whole gripping made with martensitic stainless steel



MCHB series

- Double acting / Single acting N.O.
- ϕ 12, 16, 20, 25, 32 mm
- Max. gripping force (*1) : 120 N



MCHC series

- Double acting / Single acting
- ϕ 6, 10, 16, 20, 25, 32, 40 mm
- Max. gripping force (*1) : 254 N



MCHCJ series

[Dust Cover]

- Double acting
- Tube I.D.: ϕ 16 mm
- Max. gripping force (*1) : 30 N

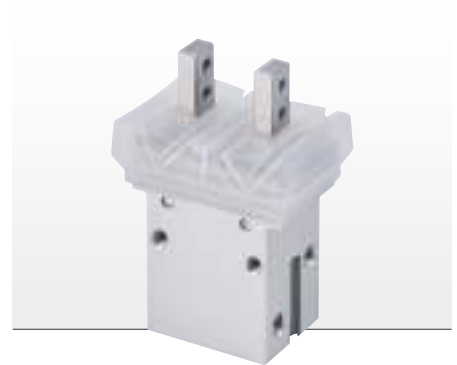

*1. Operation pressure 0.5 MPa, gripping length 20mm, the external effective gripping force for the largest bore in the series.
 *2. Operation pressure 0.6 MPa, gripping length 40mm, the external effective gripping force for the largest bore in the series.

MCHH series

- Double acting
- ϕ 20, 25, 40 mm
- Max. gripping force (*1) : 125 N



MCHS series

- Double acting
- Size: 50, 66, 80, 100, 125, 160, 200, 300
- Max. gripping force (*2) : 3411 N



MCHS-OS series

[Clamping Safety Device]

- Double acting
- Size: 80, 100, 125
- Max. gripping force (*2) : 1287 N



MCHD series

- Double acting
- ϕ 8, 12, 16, 20 mm
- Max. gripping force (*1): 140 N



MCHU series

- Double acting
- ϕ 12, 16, 20 mm
- Max. gripping force (*1): 60 N



MCHX series

- Double acting
- ϕ 10, 16, 20, 25, 32, 40 mm
- Max. gripping force (*1): 410 N





 Connect with

AIR CYLINDER

Automation equipment applications



Parallel gripper MCHD ▲ / MCHU ▼ for automatic assembly of gripping applications. Rotary actuator MCRQ with gripper MCHX for machine tool application.



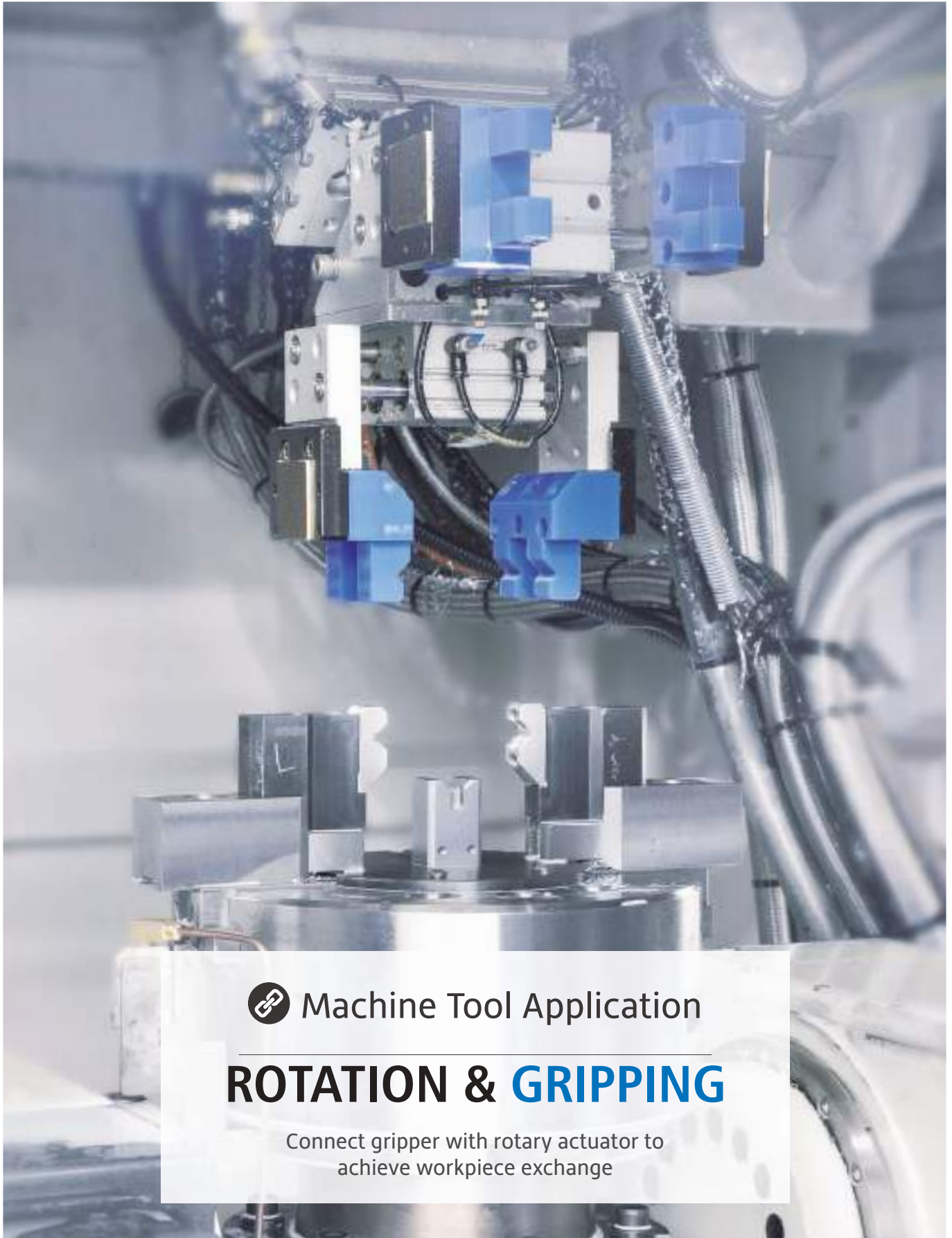

Machine Tool Application

ROTATION & GRIPPING

Connect gripper with rotary actuator to
achieve workpiece exchange

MCHG2 series

- Double acting
- ϕ 16, 20, 25, 32, 40, 50, 63, 80, 100, 125 mm
- Max. gripping force (*2) : 1270 N



MCHJ series

- Double acting
- Size: 50, 66, 80, 100, 125, 160
- Max. gripping force (*1) : 1747 N



Parallel Gripper MCHJ for die casting gripping application.

*1. Operation pressure 0.6 MPa, gripping length 40mm, the external effective gripping force for the largest bore in the series. * With dust-proof module.
 *2. Operation pressure 0.5 MPa, gripping length 50mm, the external effective gripping force for the largest bore in the series.
 *3. The external effective gripping force for the largest bore in the series.

Angular Gripper 30° / 180°

MCHA series

- Double acting / Single acting N.O.
- ϕ 12, 16, 20, 25, 32 mm
- Max. effective gripping force (*3) : 0.17 Nm
- Clamp / Release angle: -10~+30°



MCHY series

- Double acting
- ϕ 10, 16, 20, 25 mm
- Max. effective gripping force (*3) : 2.28 Nm
- Operating angle: -3~+180°

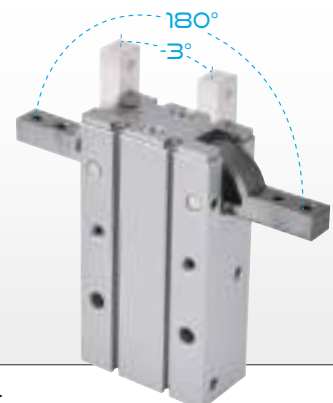

Angle gripper MCHY for assembly part clamping application.



- All-in-One module design with embedded solenoid valves and sensor switches.
- Only one I/O signal cable and one air tube is required. Plug and play.
- High reliability and simple operation compare with electric grippers.
- Wire integrated inside and power-off protection.
- Easy mounting design with threads and bolts.

MCTA-J66 series

- Double acting
- Gripper: MCHJ-66
- Max. gripping force (*1) : 188 N



MCTA-S80 series

- Double acting
- Gripper: MCHS-80
- Max. gripping force (*1) : 285 N



*1. Operation pressure 0.6 MPa, gripping length 40mm, the external effective gripping force for the largest bore in the series.

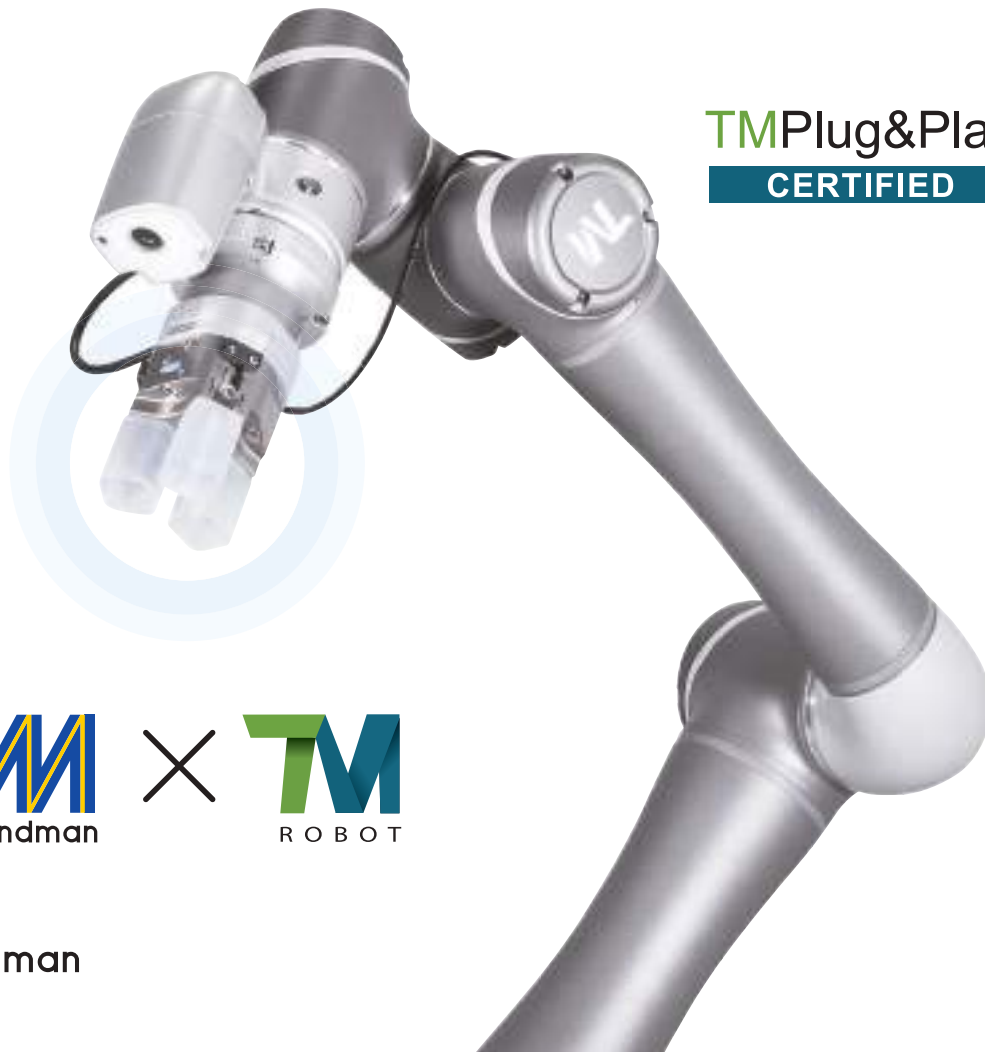

TMPlug&Play 
CERTIFIED



- High rigidity locating pins with special treatment for good service life.
- Tapered locating stud for high locating accuracy.
- Repeat accuracy ± 0.015 mm.
- Ejection mechanism for releasing base plate (R) and tool plate (T).
- Self-locking mechanism for preventing plates from ejecting when pneumatic source is accidentally removed.
- Accurate connection change with electric module to avoid manual operation mistakes.
- ISO flange for easy-mounting on most of the robot arms



Video introduction

MCTC series

- Size: 20 , 41
- handling weight :
 - Size 20: Tool : 3.5 kg [with tool plate (T)]
Workpiece : 21.5 kg
 - Size 41: Tool : 18 kg [with tool plate (T)]
Workpiece : 32 kg
- Repeat accuracy : ± 0.015 mm



180° Rotation Gripper

- Hollow shaft design for easy sensor wiring.
- Various grippers are available for exchange.
- Direct connection: Air supply tunnel connects directly to the base without piping to ensure flexibility when rotating.
- Modular rotation and gripping system for automation applications.
- Water repellent design for environment with cutter fluid.
- Magnetic as standard. Can be used with embedded sensors.

MCRT-S series

- $\varnothing 20$ mm with MCHS
Gripper size: 50, 66, 80
- $\varnothing 25$ mm with MCHS
Gripper size: 100, 125



MCRT-J series

- $\varnothing 20$ mm with MCHJ
Gripper size: 50, 66
- $\varnothing 25$ mm with MCHJ
Gripper size: 80, 100



MCRT-G series

- $\varnothing 20$ mm with MCHG2
Gripper size: $\varnothing 16, 20, 25, 32, 40$ mm
- $\varnothing 25$ mm with MCHG2
Gripper size: $\varnothing 50, 63$ mm





TRG / TRF / TAF series [For robot]

- Remove the smallest or thicker burrs on curved or straight edges, improve work efficiency and workpiece quality.
- Suitable for plastic, die-casting and machined workpieces.

Model	Compliant type	Application	Burr size	Compliant angle	Compliant force N	Spindle idle speed RPM	Cutter shank diameter mm	Tool	Workpiece type
TRG20	Radial	Curved edge	S, M	3.5°	2~10	65,000	3	Milling cutter	Plastic, die-casting
TRG30	Radial	Curved edge	L	3.5°	6~30	25,000	6	Milling cutter	Plastic, die-casting
TRF20	Radial	Curved edge	S	3.5°	5~30	9,000	5	Round file	Die-casting
TAF20	Angular	Straight edge	S	±5.5°	4~20	9,000	5	File	Die-casting

Floating mode Two types of floats mode available for different application requirements.

Angular

Floating in angular direction. Allow lateral tolerance and position change. Suitable for straight line or plane deburring.

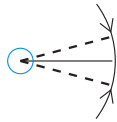

Radial

Floating in radial direction. Allow radial tolerance or position change. Suitable for complex contour deburring.

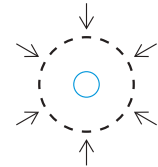



ISO Compliant



Variety of Styles



High Quality



General Environment



Special Environment



Clean Environment

Vacuum Component PISCO®

- Vacuum Generator** | Compressed air is converted to vacuum and can be combined with suction cup to transport materials.
- Vacuum Pad** | General-shape cup suitable for thick and flat work and deep-shape cup for spherical fruits (apple, etc.) or balls are available.
- Vacuum Accessories** | Swing-type suction cup bracket allows the suction cup to tilt freely. The vacuum breaking unit reduces the vacuum breaking time and can also control the vacuum breaking pressure.
- Vacuum Filter** | Filter out the dust and water drops sucked in by the vacuum generator or vacuum pump.



Semiconductor Industry



Packaging Industry

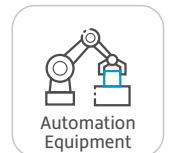

Automation Equipment



Glass Industry

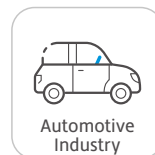

Automotive Industry



Chemical Industry

-S3 No copper-based material is used (standard)

-S3 No copper-based material is used (optional)

2in1 Two different functions integrated into one product

FOOD Food sanitation act or FDA compliant

AIR Reduce compressed air consumption

MVVA series



- Variety of nozzle diameter are available for different flow requirement.
- The basic type has a simple structure without moving parts and has a long service life.
- Equipped with solenoid valve module design to save space and easy piping.
- Sensor switch (Optional) is available for remote control.

Model	Type	Vacuum switch type*	Nozzle dia. mm	Final vacuum kPa (mmHg)	Suction flow ℓ/min	Air consumption ℓ/min	Operating pressure MPa
MVVA	Standard	SJ / EV	ø1.0, 1.5, 2.0, 2.5, 3.0	-91.8 (-690)	32~225	76~385	0.1~0.6
MVVA-S	Solenoid valve control	SJ / EV	ø1.0, 1.5, 2.0	-91.8 (-690)	21~99	50~187	0.15~0.6

* SJ : Adjustable switch / EV: Pressure switch

MVVB series [Vacuum start-upvalve / Vacuum breaker valve]



Model	Port size	Nozzle dia. mm	Final vacuum kPa (mmHg)	Suction flow ℓ/min	Air consumption ℓ/min	Supply pressure MPa	Operating pressure MPa
MVVB	Rc1/8	0.7	-90 (-675)	9	23	0.5	0.1~0.6

MVVZA series [With digital vacuum display]



Model	Nozzle number	Nozzle dia. mm	Final vacuum kPa (mmHg)	Suction flow ℓ/min	Air consumption ℓ/min	Supply pressure MPa	Operating pressure MPa
MVVZA	2	1.5	-92 (-690)	350	310	0.6	0.1~0.6
MVVZA	4	1.5	-92 (-690)	500	550	0.6	0.1~0.6

MZL112 / 212 series [Multistage]



- Adopt 3-stage cartridge, enhancing vacuum flow and saving air consumption.
- Optional solenoid valve and vacuum pressure switch.
- Internal vacuum filter and vacuum silencer. The filter element is replaceable.
- A variety of installation directions are available.

Model	Nozzle dia. mm	Max. suction flow ℓ/min	Air consumption ℓ/min	Max. vacuum pressure kPa	Max. operating pressure MPa	Supply pressure MPa
MZL112	1.2	100	63	-84	0.7	0.2~0.5
MZL212	1.2 x 2	200	126	-84	0.7	0.2~0.5



VH [Valve direct mounting type elbow]

- Compressed air is converted to vacuum and can be combined with suction cup to transport materials.
- Nozzle diameter: $\phi 0.5\text{--}\phi 2.0$
- Medium: Air
- Operating pressure: 0.15~0.7 MPa
- Operating temp.: 0~60°C (No freezing)
- Performance* : H / L / E



-S3

VS [Valve direct mounting type straight]

- Compressed air is converted to vacuum and can be combined with suction cup to transport materials.
- Nozzle diameter: $\phi 0.5\text{--}\phi 2.0$
- Medium: Air
- Operating pressure: 0.15~0.7 MPa
- Operating temp.: 0~60°C (No freezing)
- Performance* : H / L / E



-S3

VM [Vacuum pad direct mounting type elbow]

- Compressed air is converted to vacuum and can be combined with suction cup to transport materials.
- Vacuum pad direct mounting.
- Nozzle diameter: $\phi 0.3\text{--}\phi 0.5$
- Medium: Air
- Operating pressure: 0.15~0.7 MPa
- Operating temp.: 0~60°C (No freezing)
- Performance* : H / L / E



-S3

VC [Vacuum pad direct mounting type straight]

- Compressed air is converted to vacuum and can be combined with suction cup to transport materials.
- Vacuum pad direct mounting.
- Nozzle diameter: $\phi 0.3\text{--}\phi 2.0$
- Medium: Air
- Operating pressure: 0.15~0.7 MPa
- Operating temp.: 0~60°C (No freezing)
- Performance* : H / L / E



-S3

VU [Pipe type]

- Compressed air is converted to vacuum and can be combined with suction cup to transport materials.
- Nozzle diameter: $\phi 0.5\text{--}\phi 0.7$
- Medium: Air
- Operating pressure: 0.15~0.7 MPa
- Operating temp.: 0~60°C (No freezing)
- Performance* : H / L / E



-S3

VUM [Small-sized pipe type]

- Super small and lightweight ejector.
- Compressed air is converted to vacuum and can be combined with suction cup to transport materials.
- Connectable to small vacuum pad holder VPMB directly.
- Nozzle diameter: $\phi 0.3\text{--}\phi 0.5$
- Medium: Air
- Operating pressure: 0.15~0.7 MPa
- Operating temp.: 0~60°C (No freezing)
- Performance* : H / L / E

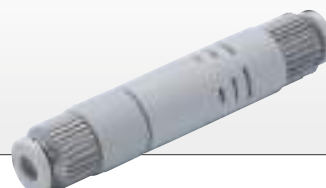

-S3

* H : High-vacuum type (Rated supply pressure: 0.5 MPa)
 L : Large-flow type (Rated supply pressure: 0.5 MPa)
 E : High-vacuum at low air pressure supply type (Rated supply pressure: 0.5 MPa)

VY [Blow-off mechanism equipped type]

- Ejector and blow-off mechanism are integrated.
- Small and lightweight body makes it possible to place on the terminal part of the vacuum piping. High speed cycle of suction and blow-off mechanism is achieved by diffuser spool.
- Nozzle diameter: $\phi 0.5\sim\phi 0.7$
- Medium: Air
- Operating pressure: 0.3~0.7 MPa
- Operating temp.: 0~60°C (No freezing)
- Performance* : H / L / E



VB [Box type]

- Integrated with mechanical vacuum switch.
- Compressed air is converted to vacuum and can be combined with suction cup to transport materials.
- Nozzle diameter: $\phi 0.5\sim\phi 1.2$
- Medium: Air
- Operating pressure: 0.15~0.7 MPa
- Operating temp.: 0~60°C (No freezing)
- Performance* : H / L / E



VLM [Multi-stage high flow]

- Securing high flow and high vacuum level.
- Excellent in ozone resistance.
- Suitable for suction conveyance, defoaming deaeration, vacuum packing, vacuum holding etc.
- Nozzle diameter: $\phi 1.6$
- Nozzle quantity: 1~6 pcs (Single, double, triple layer)
- Suction flow rate: 290~1110 l/min (ANR)
- Air consumption: 110~660 l/min (ANR)
- Medium: Air
- Operating pressure: 0.3~0.7 MPa
- Operating temp.: 5~50°C



VVV [Multi-stage nozzle]

- Ensuring high vacuum pressure & flow by low (0.35 MPa) air supply.
- 3 vacuum ports enable easy distribution.
- Easy maintenance and long life.
- Exhaust direction can be selected from straight or elbow, depending on the installation site.
- Optional digital pressure gauge to check the pressure.
- Nozzle diameter: $\phi 1.6, 2.5, 2.7$ mm
- Operating pressure: 0.3~0.7 MPa
- Rated supply pressure: 0.35 MPa
- Operating temp.: 5~50°C

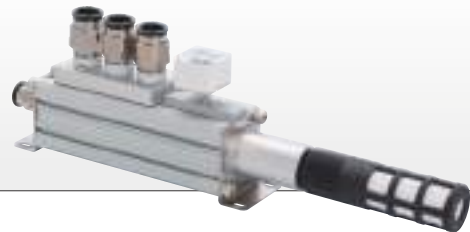

VRL [Unitasking]

- To convey small, irregular materials, such as particles, powder and fibers in the air current.
- Select the proper type according to work-piece size and the amount.
- Medium: Air / Inert gas
- Suction flow: 50~300 N l /min
- Min. dia. of flow channel: $\phi 2.8\sim\phi 7.5$ mm
- Final vacuum: -53 kPa
- Operating pressure: 0~0.9 MPa
- Rated supply pressure: 0.5 MPa
- Operating temp.: 0~60°C (No freezing)



VLS [Boxed type aluminum body]

- Nozzle diameter: $\phi 2.0, 2.5, 2.8$ mm
- Quiet operation with the cylinder type muffler.
- Pressure gauge and sensor can be installed.
- Simple structure - easy maintenance.

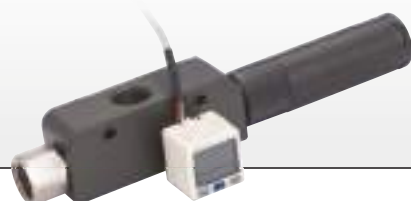

* H: High-vacuum type (Rated supply pressure: 0.5 MPa)
 L : Large-flow type (Rated supply pressure: 0.5 MPa)
 E: High-vacuum at low air pressure supply type (Rated supply pressure: 0.5 MPa)



VG series [Multi-function]

- Vacuum switch and blow-off valve is integrated. Select the best combination in accordance with applications.

Model	Medium	Performance*	Nozzle bore mm	Vacuum level kPa	Suction flow ℓ/min [ANR]	Air consumption ℓ/min [ANR]	Operating pressure MPa
VG	Air	H / L / E	ø0.5~1.0	-93 ~ -66	7 [7] ~34 [40]	11.5~46	0.25~0.7

* H : High-vacuum type (Rated supply pressure: 0.5MPa)
 L : Large-flow type (Rated supply pressure: 0.5MPa)
 E : High-vacuum at low air pressure supply type (Rated supply pressure: 0.35MPa)

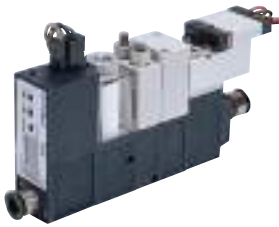

VJ series [Multi-function]

- Pressure adjusting function is added to the conventional blow-off air control function to prevent work-pieces from being blown away.
- A relief mechanism built into the blow-off circuit which breaks the vacuum (extra pressure is relieved) achieve shorter blow-off time.
- Wide variety of combinations can cope with various needs. External vacuum controller for vacuum pump series is for available. Less wiring is achieved. -S3

Model	Medium	Performance*	Nozzle bore mm	Vacuum level kPa	Suction flow ℓ/min [ANR]	Air consumption ℓ/min [ANR]	Operating pressure MPa
VJ	Air	H / L / E / K	ø0.5~1.2	-93.1 ~ -66.5	7 [7] ~ 38 [38]	11.5~70	0.3~0.7

* H : High-vacuum type (Rated supply pressure: 0.5 MPa)
 L : Large-flow type (Rated supply pressure: 0.5 MPa)
 E : High-vacuum at low air pressure supply type (Rated supply pressure: 0.35 MPa)
 K : Combination of different vacuum characteristics on mounting units on a manifold (Details should be described on Specification Order Form separately)



VK series [Multi-function] * Standing stock, fast delivery.

- Selection of the most suitable module for your application is possible by the modularized each unit and rich combination of units.
- 7 unit combinations and 18 module types.

Model	Medium	Performance*	Nozzle bore mm	Vacuum level kPa	Suction flow ℓ/min [ANR]	Air consumption ℓ/min [ANR]	Operating pressure MPa
VK	Air	H / L / E	ø0.5~1.2	-93 ~ -66.5	5.4 [5.4] ~ 37 [50]	11.5 ~ 70	0.25~0.7

* H : High-vacuum type (Rated supply pressure: 0.5 MPa)
 L : Large-flow type (Rated supply pressure: 0.5 MPa)
 E : High-vacuum at low air pressure supply type (Rated supply pressure: 0.35 MPa)



VX series [Multi-function]

- Lightweight and compact body meeting market needs.
- Pursue of faster responsiveness of suction solenoid valve to the extreme realized the high cycle of vacuum system.
- Wide variety of combinations enables to meet various applications. External vacuum controller for vacuum pump is also available.
- Max. 10 mounting units in a manifold type. -S3

Model	Medium	Performance*	Nozzle bore mm	Vacuum level kPa	Suction flow ℓ/min [ANR]	Air consumption ℓ/min [ANR]	Operating pressure MPa
VX	Air	H / L / E	ø0.5~1.0	-93.1 ~ -66.5	7 [7] ~20 [26]	8.8~46	0.3~0.7

* H : High-vacuum type (Rated supply pressure: 0.5 MPa)
 L : Large-flow type (Rated supply pressure: 0.5 MPa)
 E : High-vacuum at low air pressure supply type (Rated supply pressure: 0.35 MPa)

VN series [Multi-function] [High-speed response]



- The low-profile vacuum generator is suitable for application requiring a limited space.
- High speed, yet stable response is realized. (ON / OFF = 5msec or less)
- Tiny work piece is removed gently when releasing vacuum with blow-off.
- Common supply port type is also available.
- 20L/min. of vacuum release (blow-off) air flow is secured.
- Exhaust type: Silencer vent

Model	Medium	Nozzle bore mm	Final vacuum kPa	Suction flow ℓ /min [ANR]	Air consumption ℓ /min [ANR]	Operating pressure MPa	Rated supply pressure MPa
VN	Air	ø0.4~0.6	-90.4	1.7 [2] ~8.1 [9.5]	6 ~ 12	0~0.55	0.35~0.5

VQ series [Control large flow]



- Best suitable to control large flow with width of 31.5mm.
- The suction flow rate of double-stage pump is about 40% more flow than single stage pump.
- Exhaust method: Silencer vent, tube exhaust (ø12mm push-in fitting)



Model	Medium	Nozzle bore mm	Final vacuum kPa	Suction flow ℓ /min [ANR]	Air consumption ℓ /min [ANR]	Operating pressure MPa	Rated supply pressure MPa
VQ	Air	ø0.7~2.0	-93 ~-66	24 [24] ~ 143 [160]	23 ~ 200	0.3~0.7	0.35~0.5

Rotary Vacuum Pump

RPV series

- Realizing low driving noise, low vibration, low heat generation, low dust generation and long life.
- Light weight and compact. Space saving is realized by adoption of the special rotor form.
- The top level high efficiency in the industry is realized for the pumping speed per motor power 1(W).
1.0/1.2 [pumping speed (l/min)/motor power (W)] (50/60Hz)
- Lubrication is unnecessary by adoption of the excellent clean vacuum grease for low dust and low volatile.
- Low dust generation is realized by minimization of sliding parts. Contamination to surrounding area is controlled.
- Low noise operation and low vibration are realized by full balancing design for rotary part.
- Low generation of heat is realized by adoption of forced air-cooling system.
- RoHS and CE marking compliant. (Single-phase 100V with built-in power switch type is not compliant with CE marking.)
- Uses: Adsorption and handling, vacuum packaging, defoaming, degassing, vacuum forming, etc.
- Gas (inhaled gas): No corrosive or exposable gas, max. suction pressure: Atmospheric pressure



Model	Type	Cylinder numbers	Cylinder layout	Pumping speed ℓ /min	Final vacuum kPa G	Motor voltage V	Ambient temp. °C
RPV06A	Medium vacuum 30 ℓ	Twin	In-line	30 (50Hz) 36 (60Hz)	≤-100.95 (50Hz) ≤-101.0 (60Hz)	200/220/230 100/110/115	5~40
RPV062	Low vacuum 60 ℓ	Twin	Parallel	60 (50Hz) 72 (60Hz)	≤-97.8 (50Hz) ≤-98.3 (60Hz)	200/220/230 100/110/115	5~40
RPV063	Low vacuum 90 ℓ	Triple	Parallel	90 (50Hz) 108 (60Hz)	≤-97.8 (50Hz) ≤-98.3 (60Hz)	200/220/230	5~40
RPV064	Low vacuum 120 ℓ	Quad	Parallel	120 (50Hz) 144 (60Hz)	≤-97.8 (50Hz) ≤-98.3 (60Hz)	200/220/230	5~40



VQP series [Large flows]



- 31.5mm wide vacuum unit is designed to optimize the control of large vacuum flows.
- Easily viewable LCD dual display pressure sensor is prepared for pressure sensor.

Model	Medium	Operating pressure MPa	Working vacuum kPa	Operating temp. °C	Vibration resistant m/s ²	Impact resistance m/s ²	Protective structure
VQP	Air*, Vacuum	0.3~0.7	-100~0	5~50 (No freezing)	Below 50	Below 150	Equivalent to IEC IP40

* JIS B 8392-1 : Class1.2.1~2.4.3 compliant

VJP series [Pressure adjustment / Blow-off flow adjusting]



- Pressure adjusting function is added to conventional blow-off flow adjusting function. It enables to prevent works from being blown away.
- Wide variety of combinations enables to meet various applications. Complex vacuum generator VJ Series is also available.
- Visibility improvement by adopting LED display for vacuum switch indication.

Model	Medium	Operating pressure MPa	Working vacuum kPa	Operating temp. °C	Vibration resistant m/s ²	Impact resistance m/s ²	Protective structure
VJP	Air*, Vacuum	0.3~0.7	-100~0	5~50 (No freezing)	Below 50	Below 150	Equivalent to IEC IP40

* JIS B 8392-1 : Class1.2.1~2.4.3 compliant

VXP / VXPT series [High-cycle]



- Lightweight and compact body meeting market needs.
- The response characteristics of each type are maximized, to realize a high-cycle vacuum system.
- The 3-port specification, VXPT, has adopted a three-way vacuum supply main valve, then blow-off time is drastically shortened.
- Wide variety of combinations enables to meet various applications. Complex vacuum generator VX Series is also available. Max. 10 mounting units in a manifold type.

Model	Medium	Operating pressure MPa	Working vacuum kPa	Operating temp. °C	Vibration resistant m/s ²	Impact resistance m/s ²	Protective structure
VXP / PT	Air*, Vacuum	0.3~0.7	-100~0	5~50 (No freezing)	Below 50	Below 150	Equivalent to IEC IP40

* JIS B 8392-1 : Class1.2.1~2.4.3 compliant

VNP series [High-speed response]

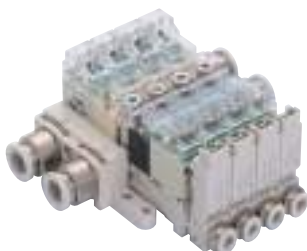

- Suitable for semiconductor industry such as IC chip loader or IC handler.
- Suitable for the application requiring a limited space.
Compact and lightweight external vacuum controller. The body height is lowered in particular.
- High-speed response time (ON / OFF = 5msec or less). Direct operated solenoid valve is used for the main valve.
- Four types of analog output type sensor are prepared.

Model	Medium	Operating pressure MPa	Working vacuum kPa	Operating temp. °C	Vibration resistant m/s ²	Impact resistance m/s ²	Protective structure
VNP	Air*, Vacuum	0~0.55	-100~0	5~50 (No freezing)	Below 50	Below 150	Equivalent to IEC IP40

* JIS B 8392-1 : Class1.2.1~2.4.3 compliant

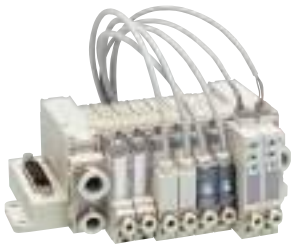

VZP series [Sub-D / Flat cable connector]

- Small in size and lightweight. External vacuum controller with bundled wiring dedicated to manifold mount.
- The electricity of valve lower to 0.55W in order to save energy.
- Easy to maintain.
- Various kinds of vacuum sensors for wide range of applications.

Model	Medium	Operating pressure MPa	Working vacuum kPa	Operating temp. °C	Vibration resistant m/s ²	Impact resistance m/s ²	Protective structure
VZP	Air*, Vacuum	0.3~0.7	-100~0	5~50 (No freezing)	Below 50	Below 150	Equivalent to IEC IP40

* JIS B 8392-1: Class1.2.1~2.4.3 compliant



VIP series [Built-in flow & pressure sensor]

- Built-in flow sensor type (Industry's first) is added to the lineup. Conventional pressure sensor mount type and no pressure sensor type are also available.
- Recommendable to semiconductor equipment (chip mounter and handler) and vacuum transfer equipment for miniature work piece.
- Ultra small body. Realizes vacuum switchover with large flow.

Model	Medium	Operating pressure MPa	Working vacuum kPa	Operating temp. °C	Vibration resistant m/s ²	Impact resistance m/s ²	Protective structure
VIP	Air*, Vacuum	0.3~0.7	-90~0	5~50 (No freezing)	Below 50	Below 150	Equivalent to IEC IP40

* JIS B 8392-1: Class1.2.1~2.4.3 compliant

No Contact Transfer











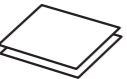
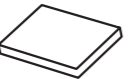

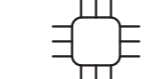

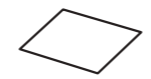

MHPSC series

- The principle of these prehension is based on the exploitation of the Bernouilli effect. A positive pressure is applied through form adequate (Insert + curve). The exhaust of this air goes through of low pressure and gets a vacuum aspiring any kind of object.
- It is used in the transfer disc, CD, DVD, pick up circuit board, eggs or fruits packaging, glass sheet leave (no mark on the surface), paper sheet with small thickness (Transfer sheet by sheet), handling of object on concave or convex surface. Handling of biscuit, wafer, paste, pastry making, membrane, sponge, textile, mirror, etc...

Model	Medium	Port size	Material	Air consumption ℓ /min	Lifting force N	Operating pressure MPa
MHPSC	Dry air filter 40μ	M3, M5	Aluminum & stainless steel	100~210	0.9~6	0.2~0.7

• Please choose the vacuum pad material and shape that suits your work and usage environment.



Application	Cardboard	Plywood	Iron plate	Food	Semiconductor	Molded product	Thin	pharmaceutical chemistry	High temperature	Low concentration ozone	Light / Ozone resistant	Humid environment	Uneven surface	Packing machine	Packaging bag	Electronic equipment parts	Liquid crystal manufacturing equipment	
Vacuum pad material / shape	Code																	
Nitrile rubber	N	●	●	●	●													
Oil resistant NBR	NH	●	●	●	●													
Urea rubber	U	●	●	●						●								
Silicone rubber	S				●	●	●		●	●		●			●			
Fluororubber	F					●		●	●	●		●			●			
Fluorosilicone rubber	FS						●		●	●		●			●			
Neoprene	C				●							●	●					
HNBR	HN	●	●	●	●					●		●						
EPDM	EP									●	●	●						
Compliant with Food Sanitation Law NBR	G	●	●	●	●							●						
Antistatic NBR [Low Resistance]	NE	●	●	●	●							●			●			●
Antistatic BR [Low Resistance]	E											●						●
Antistatic Silicone Rubber	SE				●	●	●		●			●			●			●
PEEK	K											●						●
POM	M									●		●			●			
Antistatic PEEK	KE											●						●
General	R	●	●	●		●		●	●	●	●	●						●
Deep	A				●	●		●	●	●	●	●						
Small	RM					●		●	●	●	●	●						●
Soft	L					●	●											●
Soft bellows	LB	●	●	●		●	●			●	●	●						
Skidproof	K	●	●	●	●	●	●		●									
Bellows	B	●	●	●	●	●		●	●	●	●	●			●	●	●	●
Multi-bellows	W	●	●	●	●	●		●	●	●	●	●				●		
Packaging	PB				●											●		
Ultrathin	P	●	●	●	●	●	●	●	●						●			
Flat	F				●	●		●	●						●			
Mark-free	Q					●									●			●
Sponge	S				●	●							●					
Oval	E	●	●	●	●	●		●	●	●	●	●						●

*1. Rubber material: Volume resistance of antistatic NBR (low resistance) and antistatic BR (low resistance) is 200Ω·cm or less.

*2. Rubber material: The volume resistance of antistatic silicone rubber is 105Ω·cm or less. * 3. Resin material: The volume resistance of antistatic PEEK is 105 to 106 Ω·cm.



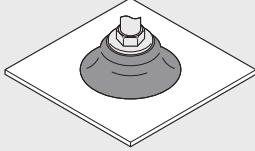
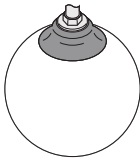

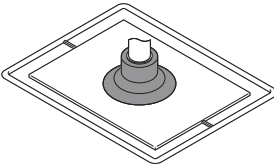
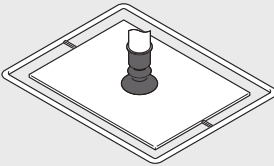
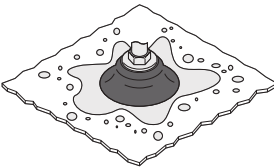
• Please select suitable pads for your application from the following.

Pad shape	Recommended workpiece	Pad size	Pad material	Features
R Standard General type 	Thick & flat work-piece	ø1~ø200	N, S, U, F, SE, E, NE, G, HN, EP	1. Small: Small work-piece and semiconductor facility. General: Best suitable for flat work-piece. Flat work-piece : Work-piece with enough hardness and thickness Deep: Suitable for round fruit or ball. Round fruit : Apple, etc.
A Standard Deep type 	Round fruit or ball (*1)	ø15~ø100	N, S, U, F, NE, G, HN, EP	2. Wide selection of pad sizes, materials and holder types. 3. Stroke length of a spring holder is selectable. 4. Variety of selections in pad holder for "Copper alloy free" and against "low ozone concentration". -S3 spec.: No copper based metal parts. HNBR or FKM is adopted for seal rubber.
RM Standard Small type 	Small work-piece or semiconductor manufacturing device	ø0.7~ø4	N, S, U, F, SE, E, NE, G, HN, EP	
L Soft 	Taking out molded parts / Fragile work-piece	ø4~ø40	N, S, FS, SE, NE	1. Various selections of pad size, pad material and holder type. Newly added pad materials for various types of work-piece. 2. Soft and flexible pad enables to pick up paper, and also leaves less mark on work-piece. 3. Downsized holders (A, B, C and D type) are available for space-saving. No need to detach a holder when replacing vacuum pad. Optional selection of Fall prevention valve and Vacuum Filter.
LB Soft bellows 	Taking out molded parts / Fragile work-piece	ø6~ø20	N, S, U, NE, HN, EP	4. Variety of selections in pad holder for "Copper alloy free" and against "low ozone concentration". -S3 spec. : No copper based metal parts. HNBR or FKM is adopted for seal rubber.
K Skidproof 	Greasy work-piece such as pressed parts	ø10~ø50	NH, S, U, F, NE	1. Vacuum Pad for Greasy Work-Piece. 2. Avoid slipping by unique pad shape design. 3. Downsized holders (A, B, C and D type) are available for space-saving. No need to detach a holder when replacing vacuum pad. Optional selection of Fall prevention valve and Vacuum Filter. 4. Variety of selections in pad holder for "Copper alloy free" and against "low ozone concentration". -S3 spec. : No copper based metal parts. HNBR or FKM is adopted for seal rubber.

*1. The table below is a reference for the vacuum pad deep type and the size of round work-piece.

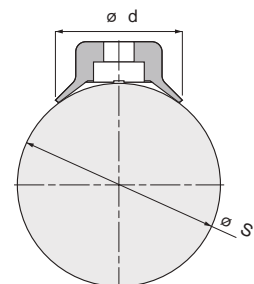
	Unit: mm								
Spherical dia. øS	ø20	ø30	ø40	ø50	ø80	ø100	ø120	ø160	ø200
Pad size ød	ø15	ø20	ø25	ø30	ø40	ø50	ø60	ø80	ø100

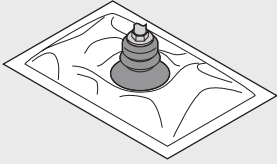
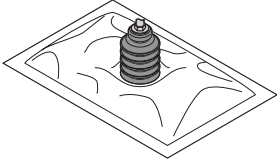

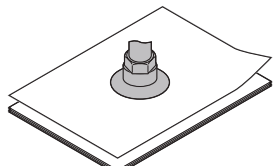
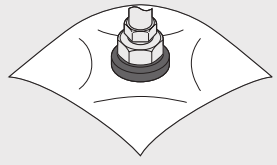
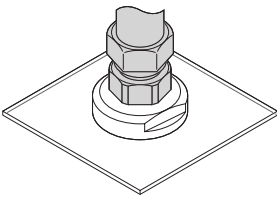
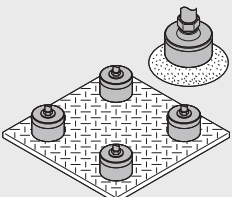
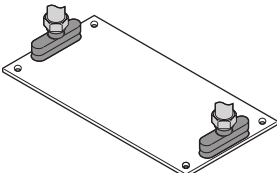
	Pad shape	Recommended workpiece	Pad size	Pad material	Features
B Bellows		Food package	ø6~ø100	N, S, U, F, SE, NE, NH, EP	<ol style="list-style-type: none"> 1. Suitable for soft work-pieces such as papers, plastic bags, etc. This pad has a characteristic of flexible motion. 2. Downsized holders (A, B, C and D type) are available for space-saving. No need to detach a holder when replacing vacuum pad. Optional selection of Fall prevention valve and Vacuum Filter. 3. Resin attachment to avoid suction marks on work-piece is now available. Best suitable for transporting of glass, painting process and taking-out molded parts. 4. Variety of selections in pad holder for "Copper alloy free" and against "low ozone concentration". -S3 spec.: No copper based metal parts. HNBR or FKM is adopted for seal rubber.
W Multi-bellows		Food package	ø10~ø50	N, S, U, F, NE, G, HN, EP	<ol style="list-style-type: none"> 1. Realize followability to speedy and precise movement of conveyance robot. 2. Pad hardness and bellows layers for selection. 3. Contributing space-saving and followability to high-speed conveyance. Compared to 5 bellows layers, approx. 25.3% shorter. 4. For work-piece contacting parts, Food Safe Act. (Japan) complied and FDA equivalent materials (*) are used. * This product is not FDA certified.
PB Packaging bags		Bag-like article conveyance	ø30~ø50	S	<ol style="list-style-type: none"> 1. Improvement in adhesion and minimizing the overlapping adhesion by the lower lip height. 2. Variety of selections in pad holder for "Copper alloy free" and against "low ozone concentration". -S3 spec.: No copper based metal parts. HNBR or FKM is adopted for seal rubber.
P Ultrathin		Thin work-piece such as paper or plastic bag	ø8~ø20	N, S, U, F, FS, NE	<ol style="list-style-type: none"> 1. Groove on a flat pad reduces deformation and wrinkle on a work-piece. 2. Variety of selections in pad holder for "Copper alloy free" and against "low ozone concentration". -S3 spec.: No copper based metal parts. HNBR or FKM is adopted for seal rubber.
F Flat		Thin work-piece such as sheet or plastic bag	ø10~ø30	N, S, U, F, NE, SE	<ol style="list-style-type: none"> 1. Flexible resin pad leaves less suction mark on work-pieces. 2. Smoothly release work-pieces by blow-off air. 3. Easy replacement of a resin pad without a spanner or a hex. key. 4. Variety of selections in pad holder for "Copper alloy free" and against "low ozone concentration". -S3 spec.: No copper based metal parts. HNBR or FKM is adopted for seal rubber.
Q Mark-free		LCD glass / in Painting process / semiconductor manufacturing device	ø10~ø30	K, M, KE	<ol style="list-style-type: none"> 1. Suitable for work-pieces with rough and uneven surface such as wall panel, small stone and seashell. 2. Downsized holders (A, B, C and D type) are available for space-saving. No need to detach a holder when replacing vacuum pad. Optional selection of Fall prevention valve and Vacuum Filter. 3. Variety of selections in pad holder for "Copper alloy free" and against "low ozone concentration". No copper based metal parts, HNBR, and FKM are adopted for seal rubber
S Sponge		Exterior wall panel, pebble, seashell	ø10~ø100	C, S	<ol style="list-style-type: none"> 1. Long work-pieces with limited suction area like circuit board and semiconductors. 2. Oval vacuum pad is with vacuum ejector. 3. Three types of switch for selection 1 Switch output+ 1 Analog output 2 Switch output 1 Analog output
E Oval		Long work-piece (e.g. circuit board and semiconductor product)	ø2×4~ø8×30	N, S, U, F, SE, E, NE, HN, EP	<ol style="list-style-type: none"> 1. Long work-pieces with limited suction area like circuit board and semiconductors. 2. Oval vacuum pad is with vacuum ejector. 3. Three types of switch for selection 1 Switch output+ 1 Analog output 2 Switch output 1 Analog output



VP* - R / A / RM [Standard]

- Pad size: $\varnothing 0.7 \sim \varnothing 200$
- Various vacuum pad material options.
- R : Best suitable for flat work-piece.
- A : Suitable for round fruit or ball.
- RM: Small work-piece and semiconductor facility.



-S3

VP* - L [Soft]

- Pad size: $\varnothing 4 \sim \varnothing 40$
- No mark on plastic molded articles.



-S3

VP* - K [Skidproof]

- Pad size: $\varnothing 10 \sim \varnothing 50$
- Vacuum pad for greasy work-piece.



-S3

VP* - LB [Soft bellows]

- Pad size: $\varnothing 6 \sim \varnothing 20$
- Vacuum pad for resin molded product.
- No mark on plastic molded articles.



-S3

VP* - B [Bellows]

- Pad size: $\varnothing 2 \sim \varnothing 100$
- Vacuum pad for retort pouch.
- Variety of selections in pad holder for "copper alloy free" and against " low ozone concentration".



-S3

VP* - W [Multi-bellows]

- Pad size: $\varnothing 6 \sim \varnothing 50$
- Vacuum pad for retort pouch.
- Variety of selections in pad holder for "copper alloy free " and against " low ozone concentration".



-S3

VP* - PB [Packaging bag]

- Pad size: $\phi 20 \sim \phi 50$
- For bag-like article conveyance.
- For work-piece contacting parts, Food Safe act.



Video Introduction



FOOD

VP* - Q [Mark-free]

- Pad size: $\phi 10 \sim \phi 30$
- Vacuum pad for smart glass, painting and semiconductor equipment.



-S3

VP* - P [Ultrathin]

- Pad size: $\phi 8 \sim \phi 20$
- Vacuum pad for paper and plastic bag.



-S3

VP* - S [Sponge]

- Pad size: $\phi 10 \sim \phi 100$
- Vacuum pad for wall panels and stones.



-S3

VP* - F [Flat]

- Pad size: $\phi 10 \sim \phi 30$
- Vacuum pad for panel and vinyl.



-S3

VP* - E [Oval]

- Pad size: $\phi 2 \times 4 \sim \phi 8 \times 30$
- Vacuum pad for circuit board and semiconductor.



-S3



VSPE [Cylinder]

- Pad size: $\varnothing 4 \sim \varnothing 40$
- Vacuum pad equipped with cylinder & Vacuum generator.



VT [Air pincette]

- Pad size: $\varnothing 1 \sim \varnothing 8$
- Vacuum pad equipped with vacuum generator.
- Air pincette equipped with vacuum pad and vacuum generator. Suitable for assembling small components.
- Valve incorporated product "VTB" makes less noise and save energy.



ECV [Fall prevention valve]

- Male thread size: M3 ~ M10, Rc1/8
- Minimize the pressure drop of other circuit when a workpiece falls down.
- Even if some vacuum pads are not operated, active vacuum pads can work normally because vacuum drop is reduced.



FH [Free holder]

- Pad size: $\varnothing 10 \sim \varnothing 100$
- Articulation angle: $30^\circ / 15^\circ$
- Suitable for picking up work-pieces with non-vertical position or with unfixed angle.



VFF [Vacuum filter pad direct mounting type]

- Operating pressure: $-100 \sim 0$ kPa
- Filtering accuracy: $10 \mu\text{m}$
- Vacuum filter for various vacuum piping.



VLF [Vacuum release unit]

- Operating pressure: $0 \sim 0.7$ MPa
- Operating vacuum pressure: $-101 \sim 0$ kPa
- Add-on blow off controller is for vacuum generators with vacuum blow-off function and controls blow-off air while maintaining characteristics of vacuum generators.



VFB [Large capacity union type for vacuum circuit]

- Dusts and drains are removed by cyclone effect and element.
- Dusts are not scattered by easy detachment of dust case.
- Operating pressure: $-100 \sim 0$ kPa
- Filtering accuracy: $10 \mu\text{m}$



VFR [Large capacity union type for exhaustion]

- Dusts and drains are removed by cyclone effect and element.
- Large dust case reduces maintenance frequency.
- Assemble to the exhaust part of vacuum generator to move the dust.
- Operating pressure: $-100 \sim 0$ kPa
- Filtering accuracy: $10 \mu\text{m}$



VFU [Small union type]

- There are 2 selections of element size depending on dust size or exchange period of the element.
- (0,1 type) Small vacuum filter is suitable for a high-cycle vacuum operation. (2,3 type) easy to assemble and stable.
- Operating pressure: $-100 \sim 0$ kPa
- Filtering accuracy: $5 \mu\text{m}$ (Trapping efficiency 95%)



VFJ [Plug-in]

- Vacuum Filter for Various Vacuum Piping
- Plug-in type with filter. PP material achieves a low price.
- Operating pressure: $-100 \sim 0$ kPa
- Filtering accuracy: $5 \mu\text{m}$ (Trapping efficiency 95%)



VFL [Large flow]

- Vacuum filter for vacuum pumps and large flow vacuum generators.
- Operating pressure: $-101 \sim 0$ kPa
- Filtration accuracy: $1, 5, 10, 200 \mu\text{m}$ (Trapping efficiency 95%)
- Bowl capacity: 90 cm^3
- Processing flow rate: 360 l/min [ANR]



MAFV302

- Remove water droplets and pollutants to ensure the quality of the vacuum gas supply system.
- Nylon cup body to adapt to a variety of environmental needs.
- Port size: $1/4, 3/8, 1/2$, Filter element: $5 \mu\text{m}$
- Operating pressure: $-100 \sim 0$ kPa
- Drain capacity: 35 cm^3





- Push-lock knob for easy pressure adjustment.
- Realized max. 50% of weight saving compared to conventional model. The main body is made of resin, and aluminum is used for the metal part.
- Best suitable for the control of the source pressure. Terminal pressure also can be controlled.

RVZ [Vacuum regulator push-lock type]

- Operating pressure: - 100~100 kPa
- Setting Pressure: - 100~1.3 kPa
- Max. suction flow rate: 30 ℓ/min[ANR]
- Operating temp.: 0~50°C (No freezing)



S3

- Vacuum generator with blow - off function which can be assembled to EOAT.
- Small and light. Nozzle bore 0.5 & 0.7 type: Height 20, Nozzle bore 1.0 & 1.2, Height 28 mm
- High speed suction / blow-off cycle. Exhaust noises are below 75dB [A].
- Built-in blow-off air storage chamber. Storage capacity of blow-off air is expandable. Extra storage chamber of blow-off air can be added by connecting a tubing with a plug cap. (Only for nozzle bore of 1.0mm & 1.2mm type.)



Video Introduction

VYR* [EOAT Direct mountable material handling vacuum generator]

- Operating pressure: - 93~-66 kPa
- Max. suction flow rate: 70 ℓ /min [ANR]



2n1

* H : High-vacuum type (Rated supply pressure: 0.5 MPa)
 L : Large-flow type (Rated supply pressure: 0.5 MPa)
 E : High-vacuum at low air pressure supply type (Rated supply pressure: 0.35 MPa)

- Plural vacuum pads can be mounted on a plate to connect to EOAT.
- Two types are available : High strength type and light weight type.
Can be used for various applications, like conveyance of heavy work-piece or light-weighting of arm tooling.
- Mounting hole for robot and cylinder is standard.
Compatible with installation sizes for articulated robots, parallel link robot and air cylinder of different companies.

VPRHT / L [Interface plates for EOAT]



- High-vacuum type. Vacuum gripper suitable for conveyance of large work-piece. Max. suction flow rate: 760 ℓ / min (The value of the three vacuum generators included creates).
- Value of built-in vacuum generator and vacuum pump compatible type is available.
- Large-flow vacuum generator is built-in. Can be directly connected to EOAT of P.C.D. 31.5, 40, 56, 80, 100.
- Once the flange mounting plate is attached to the robot arm, slide it in for easy installation. Improve operability and safety.
- 3 types of gripper are available: sponge type (O-shaped and full sponge) and hexagonally-arranged vacuum pads type. Can be used for various types of work-piece.



VRG / VMG
Adsorption demo



VRG
Features



VRG
Can handling



VMG (sponge)
Wood handling



VMG (vacuum pad)
Carton Handling

VRG [O-shaped sponge]

- Work with irregularities such as bags and PET boggles.
- Theoretical max. clamping force: 1512.7 N
- Medium: Air, Vacuum
- Operating pressure: 0.3~0.7 MPa
- Final vacuum: - 94 kPa



VLG [Full sponge] [Hexagonally-arranged]

- Mounting plate is provided to attach to the P.C.D. 31.5 robot arm.
- Built-in large flow vacuum generator. Ensure maximum suction flow: 890 ℓ /min (*). *Specification value for 4 built-in injectors.
- By installing a drop prevention valve or a check valve, workpieces can be sucked even if there are unsuctioned parts.
- Theoretical max. clamping force: 118.1 N
- Medium: Air
- Operating pressure: 0.3~0.7 MPa
- Final vacuum: - 94 kPa



VMG [Full sponge]

- Work with irregularities such as wood and exterior wall materials.
- Theoretical max. clamping force: 1546.4 N
- Medium: Air, Vacuum
- Operating pressure: 0.3~0.7 MPa
- Final vacuum: - 94 kPa



VMG [Hexagonally-arranged]

- Cardboard and bags
- Theoretical max. clamping force: 2369.5 N
- Medium: Air, Vacuum
- Operating pressure: 0.3~0.7 MPa
- Final vacuum: - 94 kPa





- Can be mounted to EOAT with P.C.D. 31.5 M5. Converting attachment for various robots of different companies are available.
- HSP type for mounting vacuum pad and HSC type for mounting gripper are available.
- Assemble to vacuum pad, 2 / 3 finger parallel gripper.

HSP / HSC [Mounting flange HS for EOAT]

- Piping: side and top
- For safety, optional protective cover, spring type (-VPF) and 2 finger parallel gripper (-CHA / -CHB)



HSP video



HSC video



HSP [For vacuum pad]



Fixed (-VPM)



Protection cover

Spring (-VPF)



Spring type low dust (-VPLFC)

HSC [For gripper]



Protection cover

2 finger - parallel gripper (-CHA / -CHB)



3 finger - parallel gripper (-CHT)



Lever gripper (-CHM)

- Max. 16 vacuum pads can be mounted on this modular kit.
- No need to design EOAT. This modular kit can be directly mounted to EOAT.
- Robot flange converting attachment* are available, which connects EOAT with a robot of different companies.

HML [Vacuum modular kit HML for EOAT]

- Adjust max width: 144, 210mm (main lever) ,120~204 mm (pad lever)
- Vacuum pad number: 4~16 pcs



Arrange range



Pad arrangement



- Unitized equipment necessary for supplying vacuum and compressed air to the EOAT (End of arm tooling).
- Unitized pneumatic equipment necessary for suction conveyance by vacuum pad and grip conveyance by gripper.
- Eliminating the need to select the necessary equipment on the pneumatic circuit. Reducing the labor of piping and installation between equipment.
- Simply connect this unit to the supply port (IN) side and output port (P or V) side to generate a vacuum or switch the air circuit.

HKU [Vacuum & air control unit]

- With vacuum generator: VK series
- Vacuum performance
 - H12 : High vacuum type (supply pressure 0.5 MPa)
 - L12 : Large flow type (supply pressure 0.5 MPa)
 - E12 : Low supply pressure high vacuum type (supply pressure 0.35 MPa)



- Easy to assemble and suction test for using general-purpose tools. "Robot flange mounting plates" are available, which connects trial kit with a robot of different companies. (sold separately)
- For suction test are available according to the application (Vacuum pad, aluminum frame, vacuum generator, air piping fitting).
- Vacuum pads and pad holders are also available.

VPGFSKIT [Vacuum pad trial kit]

- This trial kit makes possible from the initial suction test to installation on EOAT (End of arm tooling).
- Pad size: $\phi 2 \sim \phi 50$



Assembly video



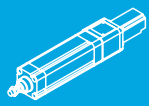

ISO Compliant



High Speed and Stability



Space Saving



High Precision



Smart Control



Patent

Electric Actuator

- High repeatability | The ball screw drive has a maximum repeatability of $\pm 0.01\text{mm}$, which is suitable for precision assembly.
- High movement speed | Belt drive maximum travel speed 3000 mm/s.
- ISO specification | Flanges comply with ISO 15552 and can be used with a variety of accessories.
- Space saving | Built-in slide rail and motor built-in design to reduce product volume.
- Lever lock patent | MESBE series, patented and won the 2022 Taiwan Excellence Award.
- Control System | The controller provides communication, pulse, and I/O control for different applications.
| The motor adopts closed-loop control, which can reduce the influence of interference or noise on the system and improve the stability of the system.



Semiconductor Industry



New Energy Industry

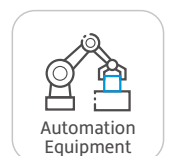

Automation Equipment



Electronics Industry



Automotive Industry



Industry 4.0

METFB series [Slider / Belt drive]

- Size-Lead: 25-50, 32-72, 40-72
- Stroke: 100~2000 mm
- Motor type: Step □ 42, 56
Servo 100, 200, 400 W
- Positioning repeatability: ±0.05 mm
- Max. speed: 2400 mm/s
- Work load: 1.5~16 kg
- Transmission: Timing belt
- Guide type: Linear guide



METB series [Slider / Belt drive]

- Size: 42, 55, 80
- Stroke: 100~6000 mm
- Moments: 20~450 Nm
- Positioning repeatability: ±0.05 mm
- Max. speed: 3000 mm/s
- Max.load: 460~4500 N
- Transmission: Timing belt
- Guide type: Linear guide

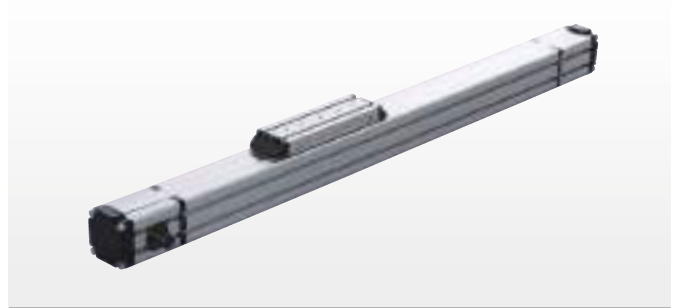

METG series [Slider / Guideway drive]

- Size: 4, 5, 8
- Stroke: 50~1100 mm
- Positioning repeatability: ±0.005 mm
- Lead: 2~20 mm
- Max. speed: 1000 mm/s
- Work load: 3~25 kg
- Motor type: Servo
- Transmission: Ball screw lead
- Guide type: Linear guide

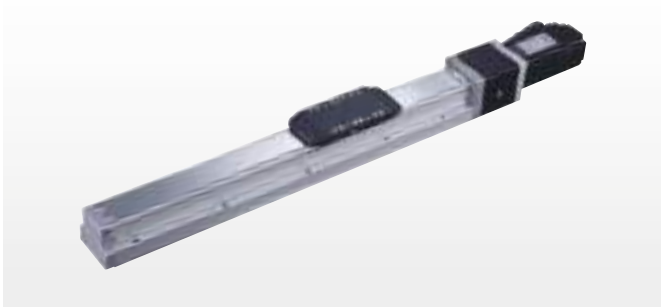

METS2 series [Slider / Ball screw drive]

- Size: 10, 14, 17, 22*
- Stroke: 100~1500 mm
- Positioning repeatability: ±0.01 mm
- Lead: 5~40 mm
- Max. speed: 2000 mm/s
- Work load: 3~150 kg
- Rated thrust: 85~2563 N
- Motor type: Servo
- Transmission: Ball screw lead
- Guide type: Linear guide
- * Size 22 is METS series



MEQG series [Rod Type / Ball screw drive]

- Size: 5, 8
- Stroke: 50~800 mm
- Positioning repeatability: ±0.01 mm
- Lead: 2~20 mm
- Max. speed: 1000 mm/s
- Work load: 3~50 kg
- Rated thrust: 85~1388 N
- Motor output: 100, 200, 400 W
- Motor type: Servo
- Transmission: Ball screw lead
- Guide type: Linear guide

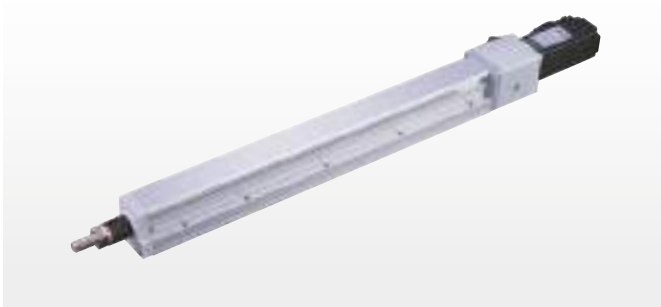

METI series [Ball screw drive] 2023 Coming soon

- Size: 32, 50
- Stroke: 50~200 mm
- Positioning repeatability: ±0.02 mm
- Lead: 2.5~20 mm
- Max. speed: 1000 mm/s
- Work load: 5~20 kg
- Rated thrust: 95~760 N
- Motor type: Step □ 42
Servo 100 W
- Transmission: Ball screw lead
- Guide type: Linear guide

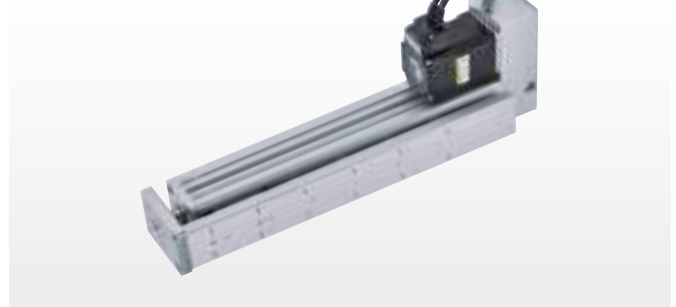

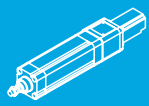

MEQI-L series [ISO 15552] 2023 Coming soon

- Size: 32, 40, 50, 63
- Stroke: 100~800 mm
- Positioning repeatability: ± 0.02 mm
- Lead: 2.5~20 mm
- Max. speed: 1000 mm/s
- Work load: 5~110 kg
- Rated thrust: 95~1560 N
- Motor size: 56
- Transmission: Ball screw lead
- Motor type: Step \square 42, Servo 100, 400 W



MEQI-T series [ISO 15552] 2023 Coming soon

- Size: 32, 40, 50, 63
- Stroke: 100~800 mm
- Positioning repeatability: ± 0.1 mm
- Lead: 1.5~4 mm
- Max. speed: 200 mm/s
- Work load: 5~80 kg
- Rated thrust: 300~1060 N
- Transmission: Trapezoidal screw
- Motor type: Step \square 42, 56, Servo 100, 400 W

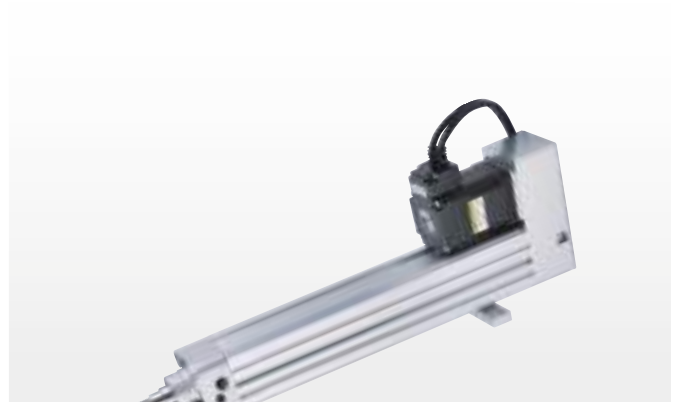

MERE series [Electric rotary actuator]

2023 Coming soon

- Size: 30
- Positioning repeatability: ± 0.05 mm
- lead angle: 12°
- Max. speed: 420 $^\circ$ /sec
- Work load: 37 kg
- Swing angle: 320, 360 $^\circ$
- Max. torque: 0.8 N.m
- Motor type: Step \square 28
- Transmission: Worm screw



MEHC2 series [Electric gripper]

- Size: 16, 25
- Gripping force: 19.5, 26 N
- Open and close stroke: 6, 14 mm
- Repeatability: ± 0.02 mm
- Gripping mass: 0.4, 0.8 kg
- Motor size: \square 20, 28 mm
- Guide type: Linear guide
- Transmission: Trapezoidal screw





1

MESH2 series

- Size: 16, 20
- Positioning repeatability: ± 0.02 mm
- Lead: 2, 8 mm
- Max. speed: $\leq 50 \sim \leq 400$ mm/s
- Work load: 0.8~6 kg
- Stroke: 30, 50 mm
- Motor size: □ 20, 28 mm
- Motor type: Step
- Transmission: Ball screw lead
- Guide type: Linear guide

2

MESF2 series

- Size: 16, 20
- Positioning repeatability: ± 0.02 mm
- Lead: 2, 8 mm
- Max. speed: $\leq 50 \sim \leq 400$ mm/s
- Work load: 0.8~6 kg
- Stroke: 30, 50, 75, 100 mm
- Motor size: □ 20, 25 mm
- Motor type: Step
- Transmission: Ball screw lead
- Guide type: Roller guide

3

MESS2 series



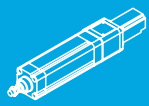

- Size: 16, 25
- Positioning repeatability: ± 0.02 mm
- Lead: 2, 8 mm
- Max. speed: $\leq 50 \sim \leq 400$ mm/s
- Work load: 0.8~6 kg
- Stroke: 30, 50, 75, 100 mm
- Motor size: □ 20, 28 mm
- Motor type: Step
- Transmission: Ball screw lead+belt
- Guide type: Cross roller guide

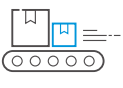

MESBE series

- Size-Stroke: 32-20, 50-30, 63-30, 80-40
- Lead: 1.5, 2.5, 2 mm
- Repeatability: ±0.1 mm
- Max. operating frequency: 5.5 c.p.m
- Motor size: □ 35, 42, 56, 80 mm
- Motor type: Step
- Transmission: Trapezoidal screw+belt



 Smart Control	 Automation Equipment	 Logistics Classification
 Self-Locking Mechanism	 Patent	 Taiwan 2022 Excellence

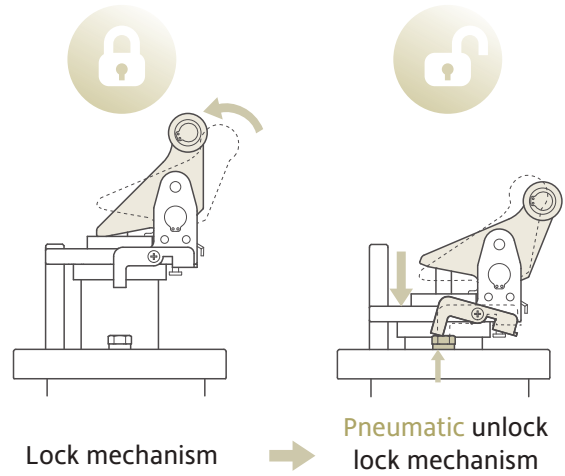

Lock mechanism prevents the light-weight workpiece from moving back by the force of shock absorber after damping.

The locking / deactivation mechanism of MSBE*-L* can be unlocked / reactivated by return the piston rod.

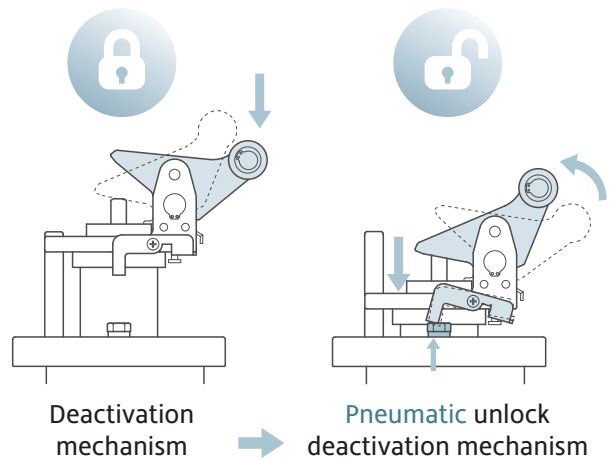

Deactivation mechanism can deactivate the cylinder without any disassembling.

The mechanism can be unlocked / reactivated by return the piston rod. Replace traditional manual unlock, which is suitable for fully automated production lines.

Electric Cylinder Controller

CK10 series [Torque type]

- Support RS-485 communication (Modbus RTU)
- Support single / double pulse control
- Support position table motion control function
- Offer dynamic-link library for PC Base (.dll for C++, C#)
- Support torque control with interrupt / continue function



CM20 series [Position type]

- Support RS-485 communication (Modbus RTU)
- Support single / double pulse control
- Programmable motion control function





Communication Protocol



High Protection



Pressure Conversion



High Precision



Remote Monitoring



Smart Control

Sensor

Sensor

- Pressure switch | High precision, slim, differential pressure, high differential pressure, gap and other multi-function options.
- Multi-Controller | 12 pressure ranges for transducer. Dual LCD display allow setting value to be displayed.
- Flow Sensor | Applicable for semiconductor manufacturing process. RS485 Modbus RTU real-time monitoring.
- Sensor switch | C slot, T slot, square, etc. can correspond to a variety of sensor grooves. Proximity, linear position, and photomicrosensor are also available.

<p>Semiconductor Industry</p>	<p>Food Industry</p>	<p>Automation Equipment</p>
<p>Medical Industry</p>	<p>Automotive Industry</p>	<p>Industry 4.0</p>

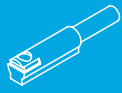
**MP1 series**

[Hysteresis adjustable]

- Setting pressure : Vacuum -101~0 kPa
Low 0~100 kPa, Positive 0~1 MPa
- Repeatability : $\leq \pm 1\%$ F.S.
- Response time : 5ms or less
- Port size : 1/8", M5×0.8

**MP10 series [Compact]**

- Compact size : 26×10×10.4 mm
- Setting pressure : Vacuum 0~ -101.3 kPa
Positive 0~0.6 MPa
- Repeatability : $\pm 1\%$ F.S.
- Response time : 1ms
- Port size : $\varnothing 4$, 6 mm, 1/8", M5×0.8

**MP30 series [Compact]**

- Setting pressure : Compound -100~100 kPa
Vacuum 0~ -101.3 kPa, Positive 0~1 MPa
- Repeatability : $\leq \pm 0.2\%$ F.S. ± 1 digit
- Response time : ≤ 2.5 ms
- Port size : 1/8", M5×0.8

**MP41 series**

[High precision]

- Setting pressure : Compound -101~101 kPa
Positive -0.1~1 MPa
- Repeatability : $\pm 0.2\%$ F.S. ± 1 digit
- Matching model : MA**302, 401, 403, 501

**MP43 series**

[High precision]

- Setting pressure : Compound -101~101 kPa
Vacuum -101.3 ~ 10 kPa
Positive -0.1~1 MPa
- Repeatability : $\pm 0.2\%$ F.S. ± 1 digit
- Response time : 2.5ms or less
- Port size : 1/8", M5×0.8, #10~32UNF



Corresponding Semiconductor

MP45 series

[High precision]

- Setting pressure : Compound -101~101 kPa
Vacuum -101.3 ~ 10 kPa
Positive -0.1~1 MPa
- Repeatability : $\pm 0.2\%$ F.S. ± 1 digit
- Response time : 2.5ms or less
- Port size : 1/8", M5×0.8, #10~32UNF



IP65

MP47 series

[High precision]

- Setting pressure : Compound -103~103 kPa
Vacuum -103 ~ 10 kPa, Positive -0.103~1.03 MPa
- Repeatability : $\pm 0.3\%$ F.S. ± 1 digit
- Response time : 2.5ms or less
- Port size : 1/8", M5×0.8, #10~32UNF
- Applicable for semiconductor manufacturing process.



Corresponding Semiconductor

Power-save

MP50 series

[High precision]

- Setting pressure : Compound -101~101 kPa
Vacuum -101.3 ~ 10 kPa
Positive -0.1~1 MPa, High -0.1~2 MPa
- Repeatability : $\pm 0.3\%$ F.S. ± 1 digit
- Response time : 2.5ms or less
- Port size : 1/4", M5×0.8
- For use in corrosive liquid or gas environments.



IP65

MP75 series

[High precision / Remote control]

- Setting pressure : Compound -101~101 kPa
Positive -0.1~1 MPa, High -0.1~2 MPa
- Repeatability : $\pm 0.3\%$ F.S. ± 1 digit
- Response time : 2.5ms or less
- Port size : 1/4", M5×0.8
- IOT pneumatic & hydraulic pressure sensor.
(multi-medium)



IP65

RS485

MP70 series

[Communication type]

- Setting pressure : Compound -101~101 kPa
Vacuum -101.3~10 kPa, Positive -0.1~1 MPa
- Repeatability : $\pm 0.2\%$ F.S. ± 1 digit
- Response time : 2.5ms or less
- Port size : 1/8", M5x0.8, #10-32 UNF
- Smart pressure sensor
- Remote control. Real-time monitoring.



Corresponding Semiconductor RS485

MP90 series [Slim]

- Setting pressure : Compound -101~101 kPa
Vacuum -101.3 ~ 10 kPa, Positive -0.1~1 MPa
- Repeatability : $\pm 0.2\%$ F.S. ± 1 digit
- Response time : 2.5ms or less
- Port size : M5x0.8
- 10 mm width with compact size
- Key-lock function



Corresponding Semiconductor

MPS series

- Pressure setting : 0.1~0.7 MPa
- Operating pressure : max. 0.8 MPa
- Operation output : Normal open ON (Red led lighting up) above value.
- Port size : 1/8"



MP800 series

[Differential pressure]

- Setting pressure : 0~1, 0~2, 0~5 kPa
-1~ 1, -2~2 , -5~5 kPa
- Repeatability : $\pm 0.5\%$ F.S. ± 1 digit
- Response time : 2ms or less
- Port size : M5
- Air flow detection, filter air monitoring.



RS485

MP7800 series

[Differential pressure]

- Setting pressure : -10~10, -1~1, -2~2, -5~5 kPa
- Repeatability : $\pm 0.5\%$ F.S. ± 1 digit
- Response time : 2ms or less
- Port size : M5
- Air flow detection, filter air monitoring.



RS485

MPDS series

[High differential pressure]

- Setting pressure : 0 ~ 1000 kPa
- Rated pressure : -1000 ~ 1000 kPa
- Repeatability : $\pm 0.2\%$ F.S. ± 1 digit
- Port size : M5
- Filter air monitoring, leakage test.



IP65 RS485

MPGS series [Gap]

- Detection distance : 0.01 ~ 0.1 mm
- Operating pressure : 250 ~ 350 kPa
- Consumption Flow Rate : $\leq 16 \ell / \text{min}$ @ 300 kPa
- Repeatability : $\pm 5 \mu\text{m}$
- Port size : 1/8"
- The gap cause by shavings can be detectable.



Video intro

IP65

MP400 series

[Multi-controller]

- Setting pressure : 12 pressure ranges for transducer
- Repeatability : $\pm 0.1\%$ F.S. ± 1 digit
- Response time : 2.5ms or less



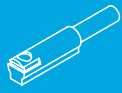

- Cost Control, user-friendly, High performance, multiple output function.
- Multiple output function
Instantaneous flow value accumulated flow value pressure value.
- 2-in-1 design
Pressure and flow rate simultaneous monitoring. (MFP01, 02 series)
- Screen invertible
Display can be vertically inverted. To set and watch monitor easily. (MF01, 02 series)
- Paint and coating flow monitoring
Air flow and pressure management of paint and coating processes.
- Laser welding monitoring
Precision management of shielding gas, flow rate and pressure.
- Suction operation
Detect the suction state of microelectronic parts by flow rate.
- Electronic part installation
Control the tension of gold wire for bonding electronic parts.
- Leakage detect
Container with gas and inspect whether it leaks.
- Air consumption monitoring: Monitor air consumption of devices.

MFO1 series [Flow]

- Measured flow rate : 0~500, 0~1000 ml/min
0~5, 0~10, 0~50, 0~100, 0~200 ℓ /min
- Working pressure : -0.09~0.8 MPa
- Repeatability : $\pm 1\%$ F.S. ± 1 digit
- Response time : Switch output min. 50ms, Analog output 100 ms or less
- Port size : $\varnothing 6, \varnothing 8, 1/8", 1/4"$



Corresponding Semiconductor RS485

MFP01 series [Flow & Pressure]

- Measured flow rate : 0~500, 0~1000 ml/min
0~5, 0~10, 0~50, 0~100, 0~200 ℓ /min
- Rated pressure : -90 ~ 800 kPa
- Repeatability : flow $\pm 1\%$ F.S. ± 1 digit, pressure $\pm 0.2\%$ F.S. ± 1 digit
- Response time : flow min. 50ms, pressure min. 2.5 ms
- Port size : $\varnothing 6, \varnothing 8, 1/8", 1/4"$



RS485

MFP02 series [Flow & Pressure]

- Measured flow rate : 2~500, 5~1000, 10~2000 ℓ /min
- Rated pressure : -90 ~ 1000 kPa
- Repeatability : flow $\pm 1\%$ F.S. ± 1 digit, pressure $\pm 0.2\%$ F.S. ± 1 digit
- Response time : flow min. 50ms, pressure min. 2.5 ms
- Port size : 1/2", 3/4"



RS485

MFO2 series [Flow]

- Measured flow rate : 2~500, 5~1000, 10~2000 ℓ /min
- Working pressure : 0~1 MPa
- Repeatability : $\pm 1\%$ F.S. ± 1 digit
- Response time : Switch output min. 50ms, Analog output 100 ms or less
- Port size : 1/2", 3/4"



Corresponding Semiconductor RS485

MFPS series [Flow & Pressure]

- 3-color indicator
- 2 Analog outputs 1 ~ 5 V
- Measured flow rate : 0~10, -10~10 ℓ /min
- Rated pressure : -100 ~ 100 kPa
- Repeatability : $\leq \pm 2\%$ F.S., pressure $\leq \pm 1\%$ F.S.
- Response time : flow ≤ 5 ms (90% Response time), pressure ≤ 1 ms
- Port size : M5x0.8



RCE series [C slot]

- Wiring method : 2, 3 wire
- Switching logic : SPST N.O., Solid state output N.O.
- Switch type : Reed switch, Non-contact, NPN current sinking, PNP current sourcing
- Voltage : DC/AC5~220V, DC10~28V, DC5~30V



RCE1 series [C slot]

- Wiring method : 2, 3 wire
- Switching logic : SPST N.O., Solid state output N.O.
- Switch type : Reed switch, Non-contact, NPN current sinking, PNP current sourcing
- Voltage : DC/AC5~120V, DC5~30V



RDEP series [C slot]

- Wiring method : 2 wire
- Switching logic : Solid state output N.O.
- Switch type : Current sourcing
- Voltage : DC10~28V



RDFE series [C slot]

- Wiring method : 2, 3 wire
- Switching logic : Solid state output N.O.
- Switch type : Non-contact, NPN current sinking, PNP current sourcing
- Voltage : DC5~30V



RDGV series [C slot]

- Wiring method : 2, 3 wire
- Switching logic : Solid state output N.O.
- Switch type : NPN current sinking, PNP current sourcing
- Voltage : DC10~28V, DC5~28V



RCD series [T slot]

- Wiring method : 2, 3 wire
- Switching logic : SPST N.O., Solid state output N.O.
- Switch type : Reed switch, Non-contact, NPN current sinking, PNP current sourcing
- Voltage : DC/AC5~120V, DC5~30V



RCI series [T slot]

- Wiring method : 2, 3 wire
- Switching logic : SPST N.O., Solid state output N.O.
- Switch type : Reed switch, NPN current sinking, PNP current sourcing
- Voltage : DC/AC5~240V, DC/AC5~120V, DC10~30V



LN32H series [T slot]

- Wiring method : 2, 3 wire
- Switching logic : SPST N.O., Solid state output N.O.
- Switch type : Reed switch, NPN current sinking, PNP current sourcing
- Voltage : DC/AC5~240V, DC10~30V



LN40R series [T slot]

- Wiring method : 2, 3 wire
- Switching logic : SPST N.O., Solid state output N.O.
- Switch type : Reed switch, NPN current sinking, PNP current sourcing
- Voltage : DC/AC5~120V, DC5~30V



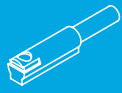

LN65 series [T slot]

- Wiring method : 2, 3 wire
- Switching logic : SPST N.O., Solid state output N.O.
- Switch type : Reed switch, Non-contact, NPN current sinking, PNP current sourcing
- Voltage : DC/AC5~240V, DC5~30V



RCA series [Square]

- Wiring method : 2, 3 wire
- Switching logic : SPST N.O., Solid state output N.O.
- Switch type : Reed switch, Non-contact, NPN current sinking, PNP current sourcing
- Voltage : DC/AC5~240V, DC5~30V



RCB series [Square]

- Wiring method : 2, 3 wire
- Switching logic : SPST N.O., Solid state output N.O.
- Switch type : Reed switch, Non-contact, NPN current sinking, PNP current sourcing
- Voltage : DC/AC5~240V, DC5~30V



RCM series [Square]

- Wiring method : 2, 3 wire
- Switching logic : SPST N.O., Solid state output N.O.
- Switch type : Reed switch, Non-contact, NPN current sinking, PNP current sourcing
- Voltage : DC/AC5~240V, DC/AC5~120V, DC10~30V, DC5~28V, DC5~30V



RCV series [Square]

- Wiring method : 2 wire
- Switching logic : SPST N.O.
- Switch type : Reed switch
- Voltage : DC/AC5~240V
- For food and pharmaceutical environment
- The switch holds up to corrosive environments, high temperature and shock.



RDKP series [Square]

- Wiring method : 2 wire
- Switching logic : Solid state output N.O.
- Switch type : Reed switch
- Voltage : DC10~28V
- Applied in the strong magnetic field environment such as automotive manufacturing or areas near welding machine.



LNO1A series

- Wiring method : 2, 3 wire
- Switching logic : N.O., Solid state output N.O.
- Switch type : Reed switch, NPN current sinking, PNP current sourcing
- Voltage : DC/AC5~240V, DC10~30V



LNO1G series

- Wiring method : 2, 3 wire
- Switching logic : N.O., Solid state output N.O.
- Switch type : Reed switch, NPN current sinking, PNP current sourcing
- Voltage : DC/AC5~240V, DC5~30V



LNO1P series

- Wiring method : 2, 3 wire
- Switching logic : N.O., Solid state output N.O.
- Switch type : Reed switch, NPN current sinking, PNP current sourcing
- Voltage : DC/AC10~220V, DC5~30V



RNKD series

[Proximity Sensor]

- Wiring method : 3 wire
- Switching logic : Solid state output N.O.
- Switch type : NPN current sinking, PNP current sourcing
- Voltage : DC10~30V



IP67

RLZ series [C, T slot]

[Linear Position]

- Freely set measuring range.
- Measuring range : 40 ± 1 mm
- Linearity error : ± 0.2 mm @ 25°C
- Repeatability : ± 0.01 mm @ 25°C
- Voltage : DC15~30V, Ripple (P-P) ≤ 10 %
- Magnetic field strength : 20 ~ 200 Gauss



IP69

RLG series [C slot]

[Magnetic Linear Position]

- 3 point positioning.
- Measuring range : 50 ± 1 mm
- Switch type : 3 NPN current sinking, 3 PNP current sourcing
- Repeatability : ± 0.01 mm
- Voltage : DC5~30V
- Magnetic requirement : 40 ~ 1000 Gauss



IP69

RJY series

[Proximity sensor]

- Body thread : M5, M8
- Wiring method : 3 wire
- Switching logic : Solid state output N.O.
- Switch type : NPN current sinking, PNP current sourcing
- Voltage : DC10~30V



IP67

Applicable

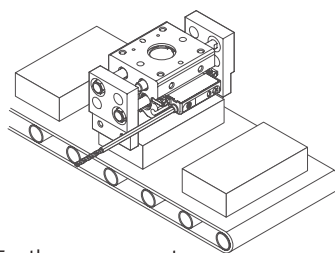

For the measurement of dimensions.

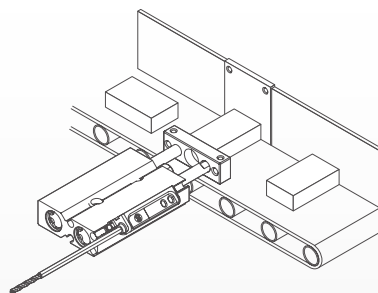

For long/short side detection.

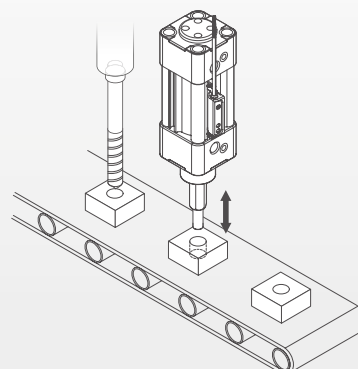

Used to check machined holes.

Setting example

State1
Gripper open

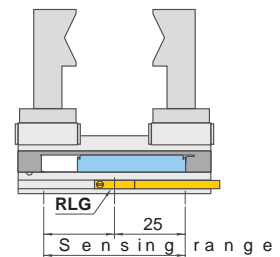

State2
Gripper close

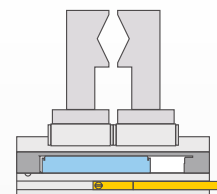

State3 : Gripping

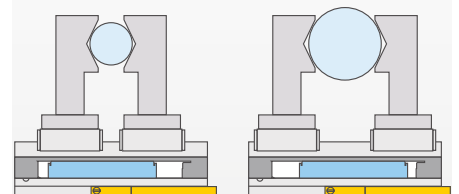

Setting procedure example for state 3.

1. Press button once, then long press until three indicators flash.
 2. Keep press button till indicator 3 flashes, then adjust gripper to gripping position.
 3. Long press button to finish.
- * Check manual for more details.

RLT series

[Slot-Type Photomicrosensor]

- Sensing distance : 6 mm (slot width)
- Sensing object : Opaque : 2×0.8 mm min.
- Switch type : NPN current sinking, PNP current sourcing
- Differential distance : Max. 0.025 mm
- Voltage : DC8~24V
- Applicable electric actuator

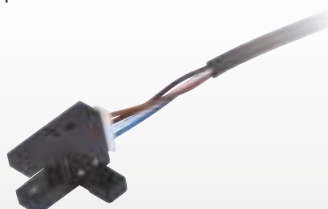

IP50



ISO Compliant



Variety of Styles



High Quality



Environmental Protection



Special Environment



Clean Environment

Fitting PISCO®

- Quality and Environmental | Obtained ISO 9001 quality certification and ISO 14001 environmental protection certification.
- General environment | One touch, minimal, functional, main block, connector.
- Special environment | For corrosive, chemical, clean environment, antistatic, spatters, brass etc..
- ⚠ Caution** | PISCO fittings are not available for sale in European region.

- S3** No copper-based material is used (standard)
- 2in1** Two different functions integrated into one product
- FOOD** Food Sanitation Act or FDA Compliant
- OIL** Oil-free
- S3** No copper-based material is used (optional)
- DUST** Clean room packaging specifications
- DUST** Cleaning and washing specifications
- AIR** Reduce compressed air consumption

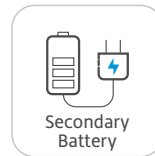
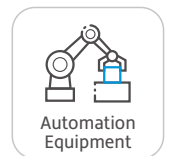

Spec.	General environment			Special environment							
	Standard	Mini	Minimal	SUS316	SUS316 compression	SUS304	SUS303 equivalent	Minimal SUS303 equivalent	Chemical	PP/SUS304	PP/SUS303 equivalent
Max. operating pressure MPa	1.0	1.0	1.0	1.0	According to pipe spec.	1.0	1.0	0.5	0.9	1.0	1.0
Operating temp. range °C	0-60	0-60	0-50	-5-150	According to pipe spec.	0-60	0-60	0-60	0-80	0-80	0-80
Environmental resistance	Corrosivity			●	●	●	●	●	●	●	●
	Water (available)	● ⁺¹			● ⁺¹	●	● ⁺¹	● ⁺¹	● ⁺²	● ⁺²	● ⁺²
	Clean-room package * ⁸	○	○	○	○	○	○	○	○	○	○
	Clean-wash * ⁹	○	○	○	○	○	○	○	○	○	○
	No copper-based material is used				●	●	●	●	●	●	●
	Low concentration ozone measures	●	●	●	●	●	●	●	●	●	●
	Oil-free * ⁶	●	●	●	●	●	●	●	●	●	●
	Antistatic resin material		●	●	●	●	●	●	●	●	●
	Flame-retarded resin (Highly resistant to spatters)		●	●	●	●	●	●	●	●	●
	Molding die temperature control		●	●	●	●	●	●	●	●	●
Other	Fitting body color	●	●								
	Release-ring color	●	●								
	O-ring material [Standard]	NBR			FKM		FKM	HNBR	FKM	EPDM	
	O-ring material [Optional]	● ⁺⁵	● ⁺⁵				● ⁺⁵	● ⁺⁵			
	Thread seal [Standard]	With sealock			No sealock		With sealock		No sealock	No sealock	No sealock
Thread seal [Optional] * ³	● ⁺⁷	● ⁺⁷		○	○	○	○	○	○	○	

● Standard ○ Optional (Standard) * ● Optional (Special) * Listed in the table, options may be indicated at the end of the order (eg -TP).

- * 1. Be sure to place insert ring (WR) into the tube edge.
- * 2. We recommend using insert ring (WR) for the tubing used in applications other than those that require no metal materials in wetted parts.
- * 3. Seal specifications are available with R (Rc) threads only.
- * 4. The gasket material will vary with the rubber material.
- * 5. All EPDM rubber grades are oil-free and cannot be combined with grease grades.



Spec.	Special environment						Functional					Main block		Connector	
	Antistatic	Fire-resistant	Brass	Brass compression	Die temperature control	Long	Stop	Rotary joint	High rotary	Multi - Circuit rotary joint	Rotary SUS304	Main block	2-Circuit junction block	Connector	Light coupling
Max. operating pressure MPa	0.6	0.9	1.0	According to pipe spec.	0.9	1.0	0.9	1.0	1.0	0.9	0.7	1.0	0.9	0.9	0.9
Operating temp. range °C	0-40	0-60	0-120	According to pipe spec.	0-120	0-60	0-60	0-60	0-60	0-60	0-60	0-60	0-60	0-60	0-60
Environmental resistance	Corrosivity											●			
	Water (available)		● ⁺¹	● ⁺¹	● ⁺¹	● ⁺¹						●		● ⁺¹	● ⁺¹
	Clean-room package * ⁸														
	Clean-wash * ⁹														
	No copper-based material is used											●			
	Low concentration ozone measures											●			
	Oil-free * ⁶	●	●	●	●	●	●	●	●	●	●	●	●	●	●
	Antistatic resin material	●	●	●	●	●	●	●	●	●	●	●	●	●	●
	Flame-retarded resin (Highly resistant to spatters)														
	Molding die temperature control														
Other	Fitting body color											○			○
	Release-ring color											○			○
	O-ring material [Standard]	NBR	NBR	HNBR	HNBR	HNBR	NBR	NBR	NBR	NBR, FKM		EDPM	NBR	NBR	NBR
	O-ring material [Optional]	● ⁺⁵	● ⁺⁵	○	○	○	● ⁺⁵	● ⁺⁵	● ⁺⁵	● ⁺⁵	● ⁺⁵	● ⁺⁵	● ⁺⁵	● ⁺⁵	● ⁺⁵
	Thread seal [Standard]	No sealock	No sealock	No sealock	No sealock	No sealock	No sealock	No sealock	No sealock	No sealock	No sealock	With sealock	No sealock	No sealock	With sealock
Thread seal [Optional] * ³	● ⁺⁷	● ⁺⁷	○	○	○	○	○	○	○	○	○	○	○	○	

- * 6. There is no intentional use of lubricants in the normal assembly process for oil-free products. Therefore, products that use rubber parts may suffer from poor sliding and poor airtightness. Products with rotary/slide parts are not included.
- * 7. Without Sealock specifications cannot be used in combination with Fluoroelastomer (FKM).
- * 8. Regarding the cleanliness and dust generation of the product, please evaluate it with an actual machine.
- * 9. If clean-wash is selected, the rubber material cannot be changed to FKM.



■ Standard ■ Mini ■ SUS #304 ● Flame-retarded ● Antistatic

PC



■ ■ ■ ● ●

POC



■ ■

PB



■ ■ ■ ● ●

PD



■ ■ ■

PE



■ ■ ■ ● ●

PEG



■ ■ ■

PL



■ ■ ■ ● ●

PLL



■ ■

PLH



■ ■

PA



■

PH



■

PAF



■

PLHJ



■ ■

PLLJ



■

PLJ



■ ■

PLGJ



■ ■

PLLGJ



■

PGJ



■ ■

PG



■ ■ ■

PU



■ ■ ■ ● ●

PW



■ ■ ■

PYJ



■ ■

PY



■ ■ ■

PWJ



■ ■

PM



■ ■

PMF



■

PML



■

PMP



■

PF



■ ■

PFF



■

PV



■ ■ ■ ● ●

PVU



■ ■

PVX



■ ■

PAU



■ ■

PTJ



■

PCF



■ ■

■ Standard ■ Mini ■ SUS #304 ● Flame-retarded ● Antistatic

PHW



■

PAW



■

PHT



■

PAT



■

PAX



■ ■

PX



■ ■

PHF



■

POL



■ ■

PRJ



■

PRX



■ ■

PRG



■ ■

PLF



■

PKD



■ ■

PKG



■ ■

PKJ



■

PKVD



■

PKVG



■

PPF



■ ■ ■

PZA



■ ■

PZB



■ ■

PZC



■ ■

PP



■ ■ ●

PIG



■

PIJ



■ ■

PCC



■

POLL



■

* The photo is a standard one-touch fitting, the appearance of other one-touch fitting types will be slightly different.

* PCC / POLL photo is a mini one-touch fitting.



Type - Minimal Fitting

■ Minimal ■ Minimal (SUS303 equivalent)

LE



■ ■

LB - F



■ ■

LH - F



■ ■

LZ



■

LD



■

LU - F



■

LL



■ ■

LB



■ ■

LH



■ ■

LC



■ ■

LG



■ ■

LU



■

LCN



■

LLC



■

LM



■

LN



■ ■

LP



■ ■

LHN



■

LS



■ ■

* The photo is a minimal fitting, and the appearance of the stainless steel version will be slightly different.
* For minimal stainless steel fitting, the ordering code is S, ex. SLE.

Release Ring Color

Brown (mm)

- Seal rubber FKM (-F)

Yellow (mm)

- Seal rubber EPDM (-E)
- Oil-free (-D)

White (inch)

- Standard package
- Clean room package
- Clean-wash package

Light gray (mm)

- Standard package
- Clean room package
- Clean-wash package

Light blue (mm)

- Clean room package
- Clean-wash package

Red (mm)

- Standard package
- Clean room package
- Clean-wash package
- Customized

Dark blue (mm)

- Stainless steel standard package
- Clean-wash package



STANDARD

- Push-in fitting for general pneumatic piping. Wide variety of products.
- Medium : Air, Water (Conditional)
- Max. operating pressure : 1.0 MPa
- Max. vacuum : - 100 kPa
- Operating temp. : 0-60°C (No freezing)
- Tube dia. : (mm) ϕ 4, 6, 8, 10, 12, 16 mm
(inch) ϕ 1/8, 5/32, 3/16, 1/4, 5/16, 3/8, 1/2, 5/8
- Thread size : M5x0.8, M6x1, R1/8, 1/4, 3/8, 1/2



MINI

- 40% smaller than the standard type fitting.
- Medium : Air
- Max. operating pressure : 1.0 MPa
- Max. vacuum : - 100 kPa
- Operating temp. : 0-60°C (No freezing)
- Tube dia. : (mm) ϕ 1.8, 2, 3, 4, 6 mm
(inch) ϕ 1/8, 5/32, 1/4
- Thread size : M3x0.5, M5x0.8, M6x1, R1/8, 1/4, 3/8

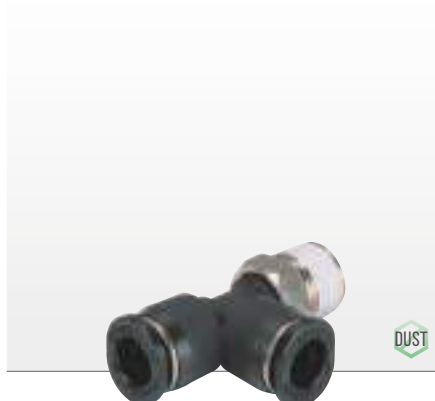

MINIMAL

- Barb joint best suitable for space-saving piping.
- They are optimal for piping vacuum equipment. (Use with vacuum tube.)
- Medium : Air
- Max. operating pressure : 0.5 MPa (0.4 MPa with vacuum tube)
- Operating temp.: - 100kPa
- Operating temp.: 0-50°C (No freezing)
- Tube dia. : (Tube O.D.) ϕ 3, 4, 5, 6 mm
(Tube I.D.) ϕ 2, 2.5, 3.5, 4 mm
- Thread size : M3x0.5, M5x0.8, M6x1, R1/8

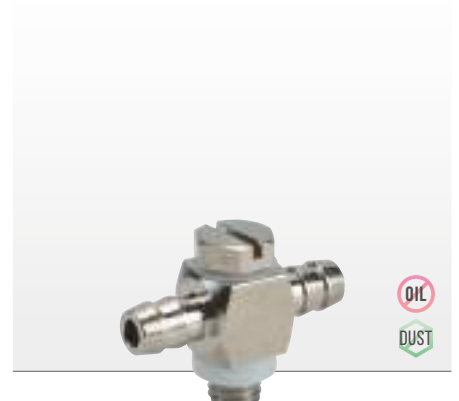

STOP

- Push-in fitting with built-in stop valve. The flow-shut mechanism will operate to stop the air flow when the tube is disconnected and allow air flow when the tube is connected.
- Easy Insertion and disconnection by double-passage structure.
- Medium : Air
- Max. operating pressure : 0.9 MPa
- Max. vacuum : - 100 kPa
- Operating temp. : 0-60°C (No freezing)
- Tube dia. : ϕ 4, 6, 8, 10, 12 mm
- Thread size : M5x0.8, R1/8, 1/4, 3/8, 1/2



ROTARY JOINT

- These piping joints are used for swiveling and swinging connections.
- Medium : Air
- Max. operating pressure: 1.0 MPa
- Max. vacuum : - 100 kPa
- Operating temp. : 0-60°C (No freezing)
- Tube dia. : (mm) ϕ 4, 6, 8, 10, 12 mm
(inch) ϕ 1/4, 5/16, 3/8
- Thread size : M5x0.8, M6x1, R1/8, 1/4, 3/8, 1/2



HIGH ROTARY JOINT

- Push-in fitting joint best suitable for high-speed swiveling and swinging connections.
- Medium : Air
- Max. operating pressure : 1.0 MPa
- Max. vacuum : - 100 kPa
- Operating temp. : 0-60°C (No freezing)
- Tube dia. : (mm) ϕ 4, 6, 8, 10, 12 mm
(inch) ϕ 1/4, 5/16, 3/8
- Thread size : M5x0.8, M6x1, R1/8, 1/4, 3/8, 1/2





MULTI-CIRCUIT ROTARY JOINT

- Best suitable for piping of index tables or other rotary equipment.
- Number of circuits: 4, 6, 8
- Medium : Air
- Max. operating pressure : 0.9 MPa
- Max. vacuum : – 100 kPa
- Operating temp. : 0~60°C (No freezing)
- Thread size : M5x0.8, M6x1, R1/8



LIGHT COUPLING

- The light coupling is small and light weight, which enable attach and detach with only one hand.
- Compatible with other manufacturer's couplings.
- Medium : Air, water (Conditional)
- Max. operating pressure : 0.9 MPa
- Max. vacuum : – 100 kPa
- Operating temp. : 0~60°C (No freezing)
- Tube dia. : ø6, 8, 10 mm
- Thread size : R1/8, 1/4, 3/8



COLOR CAP

- Color caps can be used for identification of different applications of the joints.
- Color: Black, red, orange, ocher, yellow, green, blue, sky blue, gray, white
- Sharp : Standard, mini oval, mini round
- Tube dia. : ø4, 6, 8, 10, 12, 16 mm



MAIN BLOCK

- Assembling manifold blocks for concentrated branching.
- Same flow rate with steel piping. Half size body.
- Combination with 14 types of different size blocks.
- Medium : Air
- Max. operating pressure : 1.0 MPa
- Max. vacuum : – 100 kPa
- Operating temp. : 0~60°C (No freezing)
- Tube dia. : (mm) ø4, 6, 8, 10, 12, 16 mm
(inch) ø1/2, 5/8
- Thread size : M5x0.8, M6x1, R1/8, 1/4, 3/8, 1/2, 3/4, 1



2-CIRCUIT JUNCTION BLOCK

- This add-on type concentrated branching joint serves two lines the same time.
- Medium : Air, water (Conditional)
- Max. operating pressure : 0.9 MPa
- Max. vacuum : – 100 kPa
- Operating temp. : 0~60°C (No freezing)
- Tube dia. : (Inlet-port) ø10, 12 mm
(Outlet-port) ø6, 8 mm



CONNECTOR

- The Connector realizes simultaneous connection and disconnection of multiple lines. It makes easy moving of the devices.
- Connections can be stacked or combined using Connector Band. Multiple connection with different diameter tubings.
- Medium : Air
- Max. operating pressure : 0.9 MPa
- Max. vacuum : – 100 kPa
- Operating temp. : 0~60°C (No freezing)
- Tube dia. : (mm) ø3, 4, 6, 8 mm
(inch) ø1/8, 5/32, 1/4, 5/16



SUS316

- Lock-claws type push-in fitting.
- Metal: SUS316, Seal rubber : FKM
- All materials are oil-free and compliant with Japan food sanitation act.
- Realized down-sizing (compared with Pisco's conventional products.)
- Medium: Air, water, others such as chemicals (Conditional)
- Max. operating pressure : 1.0 MPa
- Max. vacuum : - 100 kPa
- Operating temp. : - 5~150°C (No freezing)
- Tube dia. : ϕ 4, 6, 8, 10, 12, 16 mm
- Thread size : M5x0.8, R1/8, 1/4, 3/8, 1/2



SUS304

- Metal: SUS304, Seal rubber : FKM
- This tube fitting serves best where strength is required, corrosive atmosphere or the atmosphere contains chemicals.
- No copper-based material is used.
- Medium: Air, water, others such as chemicals (Conditional)
- Max. operating pressure : 1.0 MPa
- Max. vacuum : - 100 kPa
- Operating temp. : 0~60°C (No freezing)
- Tube dia. : ϕ 4, 6, 8, 10, 12, 16 mm
- Thread size : M5x0.8, R1/8, 1/4, 3/8, 1/2



SUS303 Equivalent

- Stainless steel whose corrosion resistance is equivalent to SUS303 is adopted. Seal rubber : HNBR
- Low concentration ozone measures.
- This tube fitting serves best where strength is required or corrosive atmosphere.
- Medium : Air, water (Conditional)
- Max. operating pressure : 1.0 MPa
- Max. vacuum : - 100 kPa
- Operating temp. : 0~60°C (No freezing)
- Tube dia. : ϕ 4, 6, 8, 10, 12, 16 mm
- Thread size : M5x0.8, R1/8, 1/4, 3/8, 1/2



SPATTER

- Flame-retardant resin. Resistant to flame and weld spatter. (Equivalent to V-0)
- Release-ring cover prevents malfunction of release-ring due to the weld spatter.
- Medium: Air, water (Conditional)
- Max. operating pressure : 0.9 MPa
- Max. vacuum : - 100 kPa
- Operating temp. : 0~60°C (No freezing)
- Tube dia. : ϕ 4, 6, 8, 10, 12 mm
- Thread size : M5x0.8, R1/8, 1/4, 3/8, 1/2



BRASS

- The release-ring also uses brass.
- Seal rubber: HNBR, FKM, NBR
- Resistant to flame and weld spatter.
- Medium: Air, water, heat medium oil (Conditional)
- Max. operating pressure: 1.0 MPa
- Max. vacuum : - 100 kPa
- Operating temp. : 0~100°C (No freezing)
- Tube dia. : ϕ 4, 6, 8, 10, 12 mm
- Thread size : M5x0.8, R1/8, 1/4, 3/8, 1/2



ANTISTATIC

- Suitable for electrostatic dissipating and antistatic applications.
- Medium : Air
- Max. operating pressure: 0.6 MPa
- Max. vacuum : - 100kPa
- Operating temp. : 0~40°C (No freezing)
- Volume resistance :
Conductive PBT 1x10³ Ω .cm
Conductive POM 1x10² Ω .cm
- Tube dia. : ϕ 3, 4, 6, 8, 10, 12 mm
- Thread size : M5x0.8, M6x1, R1/8, 1/4, 3/8, 1/2





MINIMAL SUS303

- Stainless steel whose corrosion resistance is equivalent to SUS303 is adopted.
- This ultra small barb fitting is best suitable for requiring corrosive resistance or use in chemical atmosphere where space-saving piping is required.
- Max 15% (approx.) smaller than conventional minimal fitting.
- Medium : Air
- Max. operating pressure : 0.5 MPa (0.4 MPa with vacuum tube)
- Max. vacuum : - 100kPa
- Operating temp. : 0~60°C (No freezing)
- Tube dia. : (Tube O.D.) ø3, 4, 6 mm (Tube I.D.) ø2, 2.5, 4 mm
- Thread size : M3x0.5, M5x0.8, M6x1



SUS316 Compression

- Compression fitting made of SUS316, which is highly resistant to corrosion. Suitable for chemical industry, medical, semiconductor, food industry, etc.
- Medium: Air, Water, Others such as chemicals (Conditional)
- Max. operating pressure: Depending on max. operating pressure of tube.
- Max. vacuum : - 100 kPa
- Operating temp. : Depending on operating temp. range of tube (No freezing)
- Tube dia.- Tube O.D.XTube I.D. : (mm) ø4x2, 4x2.5, 6x4, 8x5, 8x6, 10x6.5, 10x7.5, 10x8, 12x8, 12x9, 12x10, 16x11, 16x13 mm (inch) ø1/4x1/4, 3/8x3/8, 1/2x1/2
- Thread size: R(Rc)1/8, 1/4, 3/8, 1/2



ALL BRASS COMPRESSION

- By using special brass in the main metal body, this product line has achieved the high resistant performance against water.
- Best suitable for Auto Industry and Thermal Control for mold tooling.
- Medium : Air, Water, Others such as chemicals (Conditional)
- Max. operating pressure : Depending on max. operating pressure of tube
- Max. vacuum : - 101.3kPa
- Operating temp. : Depending on operating temp. range of tube (No freezing)
- Tube dia. : (Tube O.D.) ø4, 6, 8, 10, 12, 16 mm (Tube I.D.) ø2.5, 4, 5, 6, 6.5, 7.5, 8, 9, 11, 13 mm
- Thread size : R(Rc)1/8, 1/4, 3/8, 1/2



PP / SUS304

- PP (Polypropylene) is selected for the body material.
- Thread material : SUS304, PP Seal rubber: EPDM, FKM, HNBR ◦
- Visible fluid by transparent body color.
- Medium: Air, Water, Others such as chemicals (Conditional)
- Max. operating pressure : 1.0 MPa (at 0~20°C)
- Max. vacuum : - 100 kPa
- Operating temp. : 0~80°C (No freezing)
- Tube dia. : (mm) ø4, 6, 8, 10, 12 mm (inch) ø1/4, 3/8, 1/2
- Thread size : M3x0.5, M5x0.8, R1/8, 1/4, 3/8, 1/2



PP / SUS303 Equivalent

- PP (Polypropylene) is selected for the body material and EPDM for seal material to adapt to clean environment.
- Thread material: SUS303, PP Seal rubber: EPDM, FKM, HNBR ◦
- Visible fluid by transparent body color.
- Medium: Air, Water, Others such as chemicals (Conditional)
- Max. operating pressure : 1.0 MPa (at 0~20°C)
- Max. vacuum : - 100 kPa
- Operating temp. : 0~80°C (No freezing)
- Tube dia. : ø4, 6, 8, 10, 12 mm
- Thread size : M3x0.5, M5x0.8, R1/8, 1/4, 3/8, 1/2



CHEMICAL

- All-resin (PPS) made fitting.
- which possesses excellent heat resistance, noncombustible (UL94 V-0 equivalent) and chemical resistance and the seal is made of fluoric rubber.
- No worry for rust and metal ion.
- Oil-free for all parts and compliant with Japanese Food Sanitation Act.(only FKM option)
- Medium: Air, Water, others such as chemicals (Conditional)
- Max. operating pressure: 0.9 MPa (at 0 ~20°C)
- Max. vacuum : - 100 kPa
- Operating temp. : 0~80°C (No freezing)
- Tube dia. : ø4, 6, 8, 10, 12 mm
- Thread size : R1/8, 1/4, 3/8, 1/2



DIE TEMPERATURE CONTROL

- Molding Die Temperature control coupling.
- Push the release sleeve and remove the joint part, then you see no projection on the die.
- Medium: Air, Clean water, Heat medium oil (Conditional)
- Max. operating pressure: 0.9 MPa
- Max. vacuum : - 100 kPa
- Operating temp. : 0~120°C (No freezing)
- Tube dia. : (Tube O.D.) $\phi 4, 6, 8, 10, 12$ mm
(Tube I.D.) 1/4, 3/8
(Inner thread) Rc1/8, 1/4, 3/8
- Thread size : R1/8, 1/4, 3/8, 1/2



ROTARY JOINT SUS304

- Applicable to semiconductor field, secondary battery field, etc.
- One-touch fitting for rotating part piping for corrosive environments.
- PPS, SUS304, etc. with "chemical resistance" and "corrosion resistance" are used for wetted parts.
- No copper-based material is used. Non-grease oil-free specifications.
- Introducing a new one-touch joint for swinging and rotating parts. Two types of fluids are used: water (RWL) and air (RAL).
- Seal rubber : EPDM, FKM (Optional)
- Medium : Air, Water, Other gases (Conditional)
- Max. operating pressure : 0.7 MPa
- Max. vacuum : - 100 kPa
- Operating temp. : 0~60°C (No freezing)
- Allowable rotation speed : 500min⁻¹
- Tube dia.-Tube O.D. :
(mm) $\phi 4, 6, 8, 10, 12$ mm, (inch) $\phi 1/4, 3/8, 1/2$
- Thread size : M5x0.8, M6x1, R1/8, 1/4, 3/8, 1/2, 10-32UNF, NPT1/8, 1/4, 3/8, 1/2



water



Air



MEMO



ISO Compliant



Variety of Styles



High Quality



Environmental Protection



Special Environment



Clean Environment

Control Valve PISCO®

Quality and Environmental | Obtained ISO 9001 quality certification and ISO 14001 environmental protection certification.

General environment | Speed controller, needle valve, quick exhaust valve, pressure regulator, check valve, silencer

Special environment | Corrosion resistance and spatter speed controller, stainless steel needle valve, clean room, fluororesin needle valve

-S3 No copper-based material is used (standard)

2in1 Two different functions integrated into one product

FOOD Food Sanitation Act or FDA Compliant

OIL Oil-free

-S3 No copper-based material is used (optional)

DUST Clean room packaging specifications

DUST Cleaning and washing specifications

AIR Reduce compressed air consumption



Semiconductor Industry



Food Industry

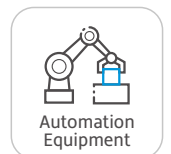

Automation Equipment



Pharmaceutical Industry

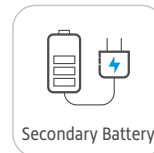

Secondary Battery



Chemical Industry



* Applicable to standard type, PP material, brass.

	General environment							Special environment					
Series	Speed controller												
	Standard	Large flow	Low flow	Push-Lock	Slot-head	Cushion	Constant flow	SUS316	SUS303 equivalent	PP	Fire-resistant	Brass	
	Throttle (needle) valve							SUS316		PP		Brass	
	Standard							SUS316		PP		Brass	
Spec.	Max. operating pressure MPa												
	0.9	0.7	0.9	1.0	0.9	1.0	0.9	0.9	0.9	1.0	0.9	1.0	
	0~60							-5~60		0~60		0~80	
	0~60							-5~150		0~80		0~100	
	0~60							-5~150		0~80		0~120	
Environmental resistance	Corrosivity												
								●		●			
								●		●		●	
	Water (available) *1												
								●		●		●	
	Clean-room package												
	○		○		○			○		○			
	No copper-based material is used												
								●		●		●	
	Low concentration ozone measures												
								●		●		●	
								FKM		HNBR		FKM, HNBR	
	Oil-free												
								●		●			
	Antistatic resin material												
								●				●	
	Flame-retarded resin (Highly resistant to spatters)												
										●		●	
Other	Fitting body color												
	○			○				●					
	W: Light gray			W: Light gray				W: Light gray					
	Release-ring color												
	●			●				●					
	-RR: Red *4							-RR: Red					
	O-ring material [Standard]												
	NBR	NBR	NBR	NBR	NBR	NBR,HNBR	NBR	HNBR	EPDM	NBR	HNBR	HNBR	
	O-ring material [Optional]												
	●			●				●		○		○	
	-F: FKM, -E: EPDM, -HN: HNBR							-F: FKM, -E: EPDM		-F: FKM, -HN: HNBR		-F: FKM	
	Thread seal [Standard]												
	With sealock			With sealock				With sealock		No sealock		With sealock	
	Thread seal [Optional] *2												
	●			●				○		●		○	
	-P: No sealock							-TP: Seal tape on thread		-P: no sealock		-TP: Seal tape on thread	
										S: With sealock			

● Standard ○ Optional (Standard) * ● Optional (Special) * Listed in the table, options may be indicated at the end of the order (eg -TP).

- * 1. Be sure to place insert ring (WR) into the tube edge.
- * 2. Seal specifications are available with R (Rc) threads only.
- * 3. The gasket material will vary with the rubber material.
- * 4. Available only if the resin color is black.



With sealock-coating No sealock-coating

JS* [Standard]

- The most standard speed control valve for driving devices.
- Free, mini, universal, large flow, low flow etc optional.
- Packaging option: Standard, C : Clean room package, W: Light-gray body, W-C : Light-gray body + Clean room pkg.
- Medium: Air
- Operating pressure : 0.05~1.0 MPa
- Check valve opening pressure : 0.005 ~0.05 MPa
- Operating temp. : 0~60°C (No freezing)



JKC / JKL [Constant flow]

- This speed controller fixes the operation speed of driving device.
- It is best suited for use with mass-produced dedicated machines.
- Medium : Air
- Operating pressure : 0.1~0.9 MPa
- Check valve opening pressure : 0.05 MPa
- Operating temp. : 0~60°C (No freezing)



JSG* [Push-lock type]

- Speed setting can be checked with indicator.
 - Easy adjustment due to its liner characteristics.
 - Easy to identify the flow direction by the knob color.
 - Medium: Air
 - Operating pressure : 0.01~1.0 MPa
 - Check valve opening pressure : 0.05 MPa
 - Operating temp. : 0~60°C (No freezing)
 - Push-Lock type knob. Easy to handle.
- Flow rate can be set by 30 steps in one turn.
* The number of turn is visible every 1/2 turn.

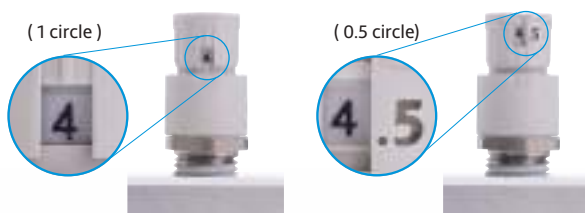

Push-lock display (side up, down, top adjustment)



JSDC / JSDS [Slot-head]

- It prevents unnecessary manual adjustments during the operations.
- Use a slot screwdriver to adjust the needle (speed adjustment).
- Approx. 2/3 height of the conventional Speed Controller. Suitable for a small space.
- Medium : Air
- Operating pressure : 0.1~0.9 MPa
- Check valve opening pressure : 0.05 MPa
- Operating temp. : 0~60°C (No freezing)



BJSU [2-stage speed controller]

- Industry's first ! It enables same control as the cylinder with shock absorber. (Patent no. 5578502)
- Shock absorber is not required. Two-stage exhaust flow rate adjustment is realized. By using 2nd stage exhaust speed to be as cushion (brake), controlling like a shock absorber is possible.
- Speed control (EX1), shock absorbing (cushion) strength (EX2), and start timing of shock absorber (TIM) are separately adjustable.
- Medium : Air
- Operating pressure : 0.2~1.0 MPa
- Operating temp. : 0~60°C (No freezing)





SJSC [SUS303 like corrosivity]

- Best suitable for operating where strength is required or in corrosive atmosphere.
- Stainless steel whose corrosion resistance is equivalent to SUS303 is adopted. Copper alloy free material for metal parts.
- HNBR for seal rubber against low ozone concentration.
- Medium : Air • Operating pressure : 0.1~0.9 MPa
- Check valve opening pressure : 0.05 MPa
- Operating temp. : 0~60°C (No freezing)



-S3

SSJSC [SUS316]

- The same lock-claws system as tube fitting is adopted.
- External parts are made of SUS316 that has excellent anti-corrosive characteristics.
- The material of sealing rubber is FKM (One of diaphragm is HNBR).
- Packaging option: Standard package, clean room package
- Medium: Air • Operating pressure : 0.1~0.9 MPa
- Check valve opening pressure : 0.05 MPa
- Operating temp. : -5~60°C (No freezing)



-S3
FOOD
OIL
DUST

JSC- * - V-O [Speed controller spatter]

- A fire-resistant resin (equivalent to UL V-0) is applied for the body material to adapt to spatter environment.
- Protective Cover at both needle and joint parts to protect from sparks.
- Medium: Air • Operating temp. : 0~60°C (No freezing)
- Operating pressure : 0.1~0.9 MPa, 0.05~0.5 MPa (Low cracking pressure type)
- Check valve opening pressure : 0.05 MPa, 0.02 MPa (Low cracking pressure type)



PJS* [PP material]

- PP (polypropylene) is applied for the body material to adapt to clean environment.
- Seal rubber: EPDM (standard), FKM, HNBR
- Packaging option: Standard package, clean room package
- Medium: Air, other (conditional)
- Operating pressure : 0.05~1.0 MPa (at 0~20°C)
- Check valve opening pressure : 0.005~0.05 MPa
- Operating temp.: 0~80°C (No freezing)



-S3
FOOD
OIL
DUST

JKSC [Brass material]

- Not only the body but the release ring is made of brass, thus best suitable for high heat and spatter environments.
- Seal rubber : HNBR, FKM
- Medium : Air
- Operating pressure : 0.1~1.0 MPa
- Check valve opening pressure : 0.05 MPa
- Operating temp. : 0~100°C (HNBR), 0~120°C (FKM) (No freezing)



Knob Difference

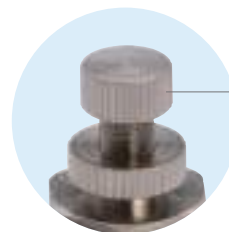

Speed controller



Throttle (Needle) Valve

* Applicable to standard type, PP material, brass.

JNC / S / MU [Standard]

- Throttle valve controls the operation speed of a pneumatic device and the transmission of air pressure signals. The flow rate can be adjusted while the air is flowing.
- Rotatable Resin body and fitting for free type (JNS).
- Packaging option : Standard, C : Clean room package, W : Light-gray body, W-C : Light-gray body + clean room pkg.
- Medium: Air
- Max. operating pressure : 0.9 MPa ~ 1.0 MPa (JNMU)
- Operating temp. : 0~60°C (No freezing)
- Max. vacuum : -100 kPa



SSJNC [SUS316]

- The same lock-claws system as tube fitting is adopted.
- Needle valve made of stainless steel SUS316 which has excellent anti-corrosivity. Seal rubber : FKM
- Packaging option: Standard package, clean room package
- Medium: air, water, other chemicals (Proviso)
- Max. operating pressure : 1.0 MPa
- Max. vacuum : -100 kPa
- Operating temp. : -5~150°C (No freezing)



PJN* [PP material]

- PP (polypropylene) body material for clean environment.
- Visible fluid by semi-transparent body color.
- Seal rubber : EPDM (standard), FKM, HNBR
- Packaging option : Standard package, clean room package
- Medium : Air, water, others such as chemicals (Conditional)
- Max. operating pressure : 1.0 MPa (at 0~20°C)
- Max. vacuum: -100 kPa
- Operating temp. : 0~80°C (No freezing)



KJNC [Brass material]

- Not only the body but the release ring is made of brass, the best suitable for high heat and spatter environments.
- Seal rubber: HNBR, FKM
- Operating temp. : 0~100°C (HNBR), 0~120°C (FKM) (No freezing)
- Medium : Air
- Max. operating pressure : 1.0 MPa
- Max. vacuum : -100 kPa



ET [Exhaust needle valve]

- This Exhaust needle valve with silencer controls the exhaust flow rate.
- Lower price than speed controller.
- Medium : Air
- Max. operating pressure : 0~0.9 MPa
- Operating temp. : 0~60°C (No freezing)





EQ [Quick exhaust valve]

- Best suitable for high-speed drive cylinder.
- Standard quick exhaust valve series is equipped with silencer.
Re-adjustment of exhaust flow is not necessary when replacing silencer element.
- Medium : Air
- Operating pressure : 0.1 ~ 0.7 MPa
- Min. opening pressure : 0.05 MPa
- Operating temp. : 5~60°C (No freezing)



EQ* [Quick exhaust valve mini type]

- An eco (energy-saving) type with a tube outer diameter of $\phi 3$ mm is available for mini.
- Reduced annual air consumption by 90,000L by reducing the size from $\phi 4$ mm to $\phi 3$ mm. (According to our conditions)
- Added socket type (EQJ) to Mini.
- Operating pressure : 0.1 ~ 0.7 MPa
- Min. opening pressure : 0.05 MPa
- Operating temp. : 5~60°C (No freezing)



RV* [Regulator push-lock type]

- Pressure adjustment work is easy with the push-lock type knob.
A compact regulator that allows pressure adjustment in the middle of piping due to its compact design.
- Comes with a relief mechanism that is convenient for adjusting equipment. With backflow mechanism.
- Medium: Air
- Operating pressure : 0 ~ 1.0 MPa
- Pressure setting : 0.1 ~ 0.8 MPa
- Indicated pressure : 0 ~ 0.8 MPa
- Accuracy (gauge) : $\pm 5\%$ F.S.
- Operating temp. : 0~60°C (No freezing)



JPC / S [Pressure controller]

- In driving an actuator under high pressure, compressed air can be saved by use of the pressure controller to reduce the pressure only during home return.
- Controls the pressure for advance and return of an actuator.
- Medium : Air
- Operating pressure : 0 ~ 0.9 MPa
- Pressure setting : 0.2 ~ 0.6 MPa
- Operating temp. : 0~60°C (No freezing)



PC / PL [Fixed orifice joint]

- Lower price than throttle (needle) valve.
- Installable in small space.
- 18 types of orifice bore.
- Medium : Air
- Max. operating pressure : 1.0 MPa
- Max. vacuum : -100 kPa
- Operating temp. : 0~60°C (No freezing)



RVFUP [Pre-set pressure regulator]

- Factory preset enables reduction of pressure adjusting time in the assembly process. No adjustment of downstream pressure is needed.
- Tamper-proof - prevents unwanted adjustments. There is no pressure adjusting screw nor knob.
- The body volume is reduced by 33% compared with the RVUP model.
- Medium : Air
- Operating pressure : Preset pressure~1.0 MPa
- Operating temp. : 0~60°C (No freezing)
- Pressure tolerance : ± 0.025 MPa (When preset pressure+0.3 MPa is supplied)



CV* [Check valve]

- Check valve permits the air flow in one direction but checks the flow in the opposite direction, thus keeping the output pressure at a constant level.
- Low-cost and lightweight resin type
- Medium : Air
- Max. operating pressure : 0.9 MPa
- Max. vacuum : -100 kPa
- Min. opening pressure : 0.01 MPa or less
- Min. opening differential pressure : 0.02 MPa (Metal poppet), 0.04 MPa (Resin poppet)
- Operating temp. : 0-60°C (No freezing)



PCVLU [Check valve PP for low operating pressure]

- PP (polypropylene) is applied for the body material to adapt to clean environment.
- Clear (semitransparent) color used for the resin body makes it possible to check visually the fluid (liquid) inside. Easy to check sanitary condition.
- SUS304 is used for the metal parts. FKM is used for valve packing. EPDM is used for elastic sleeve (FKM and NBR are optional).
- Medium: Air, water, others such as chemicals (Conditional)
- Max. operating pressure : 1.0 MPa (at 0-20°C)
- Max. vacuum : -100 kPa
- Min. opening pressure : 5 kPa (at 25°C)
- Min. opening differential pressure : 0.01 MPa
- Operating temp. : 0-80°C (No freezing)



SFU

[Positive-negative pressure union filter]

- Element can be replaced without any tool, easy maintenance.
- Suitable as pre-filter in positive pressure system.
- Medium : Air
- Max. operating pressure : 1.0 MPa (at 20°C)
- Max. vacuum : -100 kPa
- Filtering accuracy : 5 μm (Trapping efficiency 95%)
- Operating temp. : 0-50°C (No freezing)



MFU [Hollow fiber membrane filter]

- Small body, lightweight and large flow rate.
- Filtering accuracy : 0.01 μm, correcting Efficiency: 99.99%
- Suitable for semiconductors, measuring instruments, printing and medical fields.
- Explosion-proof structure by a plastic body covering the filter case.
- Medium : Air, nitrogen
- Operating pressure : 1.0 MPa (at 20°C)
- Max. vacuum : -100 kPa
- Filtering accuracy : 0.01 μm (Trapping efficiency 99.99%)
- Operating temp. : 5-50°C



SR / T / M [Silencer]

- Silencer, connected to the exhaust port of a device, suppresses the exhaust noise.
- Excellent silencing effect.
- Selection from 3 types. Selection from taper thread type, metric thread type and push-in fitting type.
- Medium : Air
- Operating pressure : 0-0.9 MPa
- Operating temp. : 0-60°C (No freezing)



[Check Valve]



VUS21* [LED digital pressure sensor]

- LED displays are used for set-up pressure and working pressure.
- 2 points signal output type and 1point signal output with 1 analog output type is available.
- Output detection accuracy is enhanced by the use of semiconductor switch.
- Current consumption : 40mA or less
- Operating pressure : -100 ~ 0 kPa
- Pressure setting : -99 ~ 0 kPa
- Operating temp. : 0~50°C (No freezing)
- Protective structure : IEC standard IP40 equiv.



GP [Pressure gauge]

- Compact body, which can fit to small space.
- The built-in tube fitting type can indicate pressure only by inserting a tube.
- Medium : Air
- Indicated pressure range (gauge) : 0~0.8 MPa
- Operating temp. : 0~60°C (No freezing)
- Tolerance : ± 5% (Full scale)
- Scale angle : 150°



MEMO



ISO Compliant



Variety of Styles



High Quality



Environmental Protection



Special Environment



Clean Environment

Tube PISCO®

Quality and Environmental | Obtained ISO 9001 quality certification and ISO 14001 environmental protection certification.

General environment | Polyurethane type, vacuum tube, nylon type, multi-colored ribbon tube, spiral coiled tube.

Special environment | Fluoropolymer tube, polyolefin tube, anti-spatter, anti-static.

-S3 No copper-based material is used (standard)

DUST Clean room packaging specifications

FOOD Food sanitation act or FDA compliant

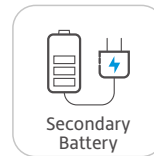
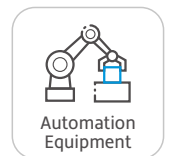
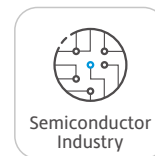

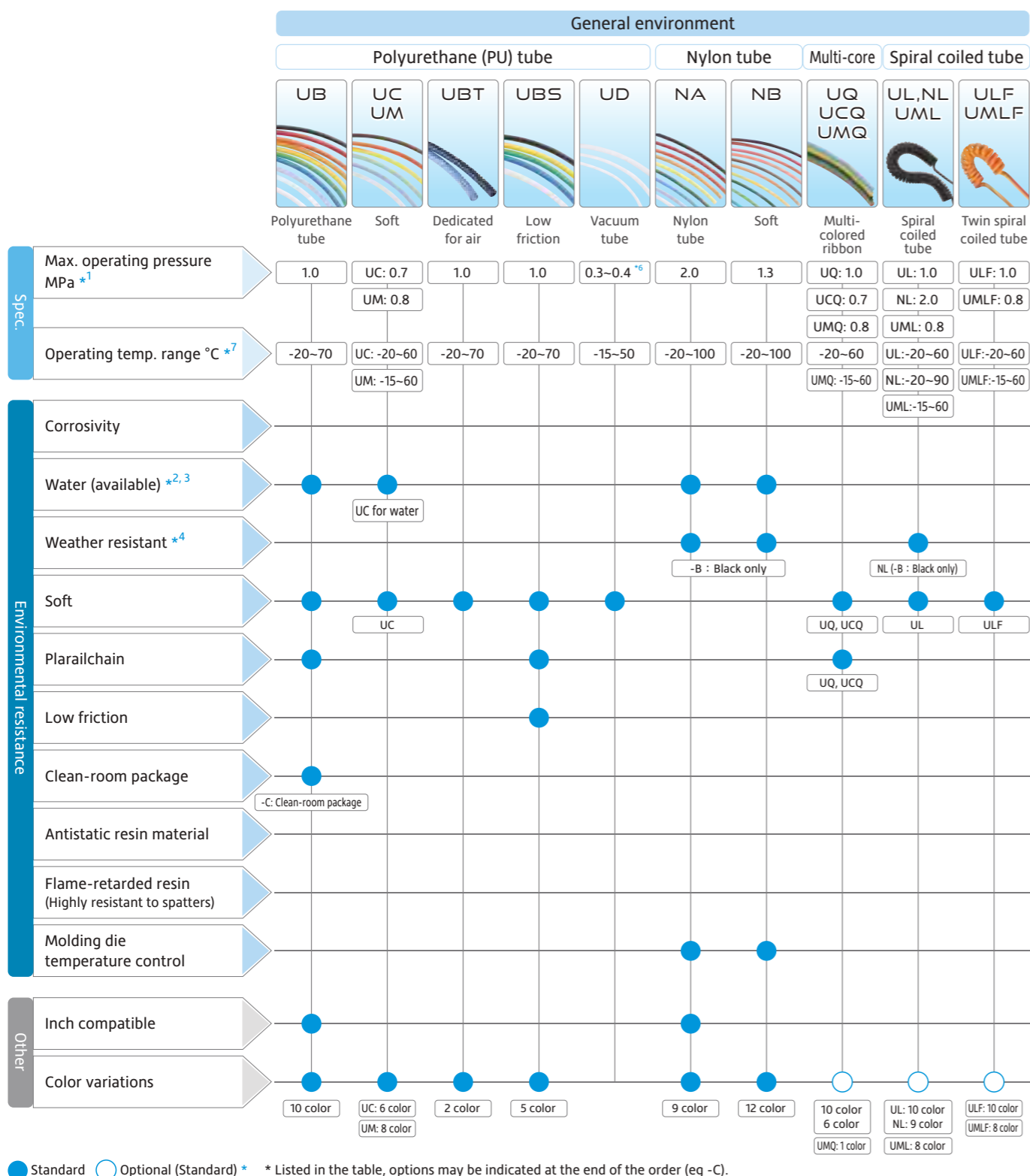

● Standard ○ Optional (Standard) * Listed in the table, options may be indicated at the end of the order (eg -C).

*1. The maximum operating pressure is at 20°C, 65%RH.
 *2. Be sure to place insert ring (WR) into the tube edge.
 *3. When using resin one-touch fittings (chemical/PP type) in fields other than those requiring no use of metal materials, we recommend using an insert ring (WR) for the tube.
 *4. Not suitable for outdoor use.
 *5. The cover part is made of PVC.
 *6. Note! The maximum operating pressure of the vacuum tube and fluoro resin tube differs depending on the piping size.
 *7. The indicated temperature range is for when the fluid used is air. Please note that the operating temperature range differs for liquids.

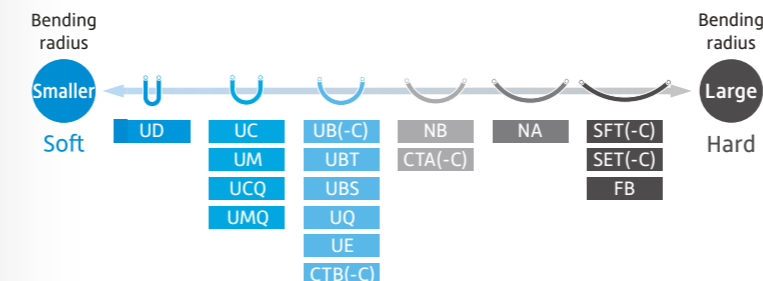
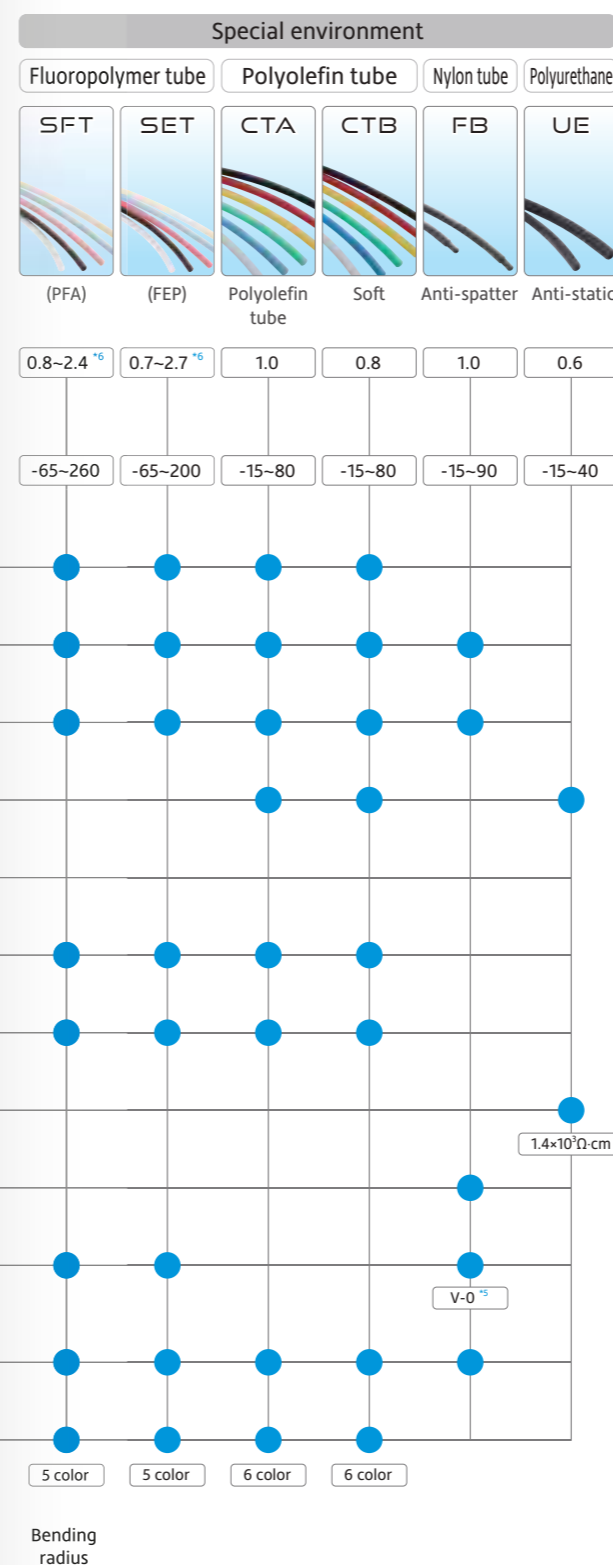

Tube size (O.D.×I.D.) Unit: ømm

mm

Polyurethane tube

Size Type	1.8x1	2x1.2	3x2	4x2.5	6x4	8x5	10x6.5	12x8	16x11
UB	●	●	●	●	●	●	●	●	●
UC	-	-	-	●	●	●	●	●	-
UM	-	-	-	●	●	●	●	●	●
UBT	-	-	●	●	●	●	●	●	-
UBS	-	-	-	●	●	●	●	●	-
UD	-	-	-	●	●	● (8x6)	● (10x7.5)	● (12x9)	-
UQ	-	-	●	●	●	●	●	●	-
UMQ	-	-	-	●	●	●	●	●	-
UL	-	-	●	●	●	●	●	●	-
UML	-	-	-	●	●	●	●	●	-
ULF	-	-	-	●	●	●	●	●	-
UMLF	-	-	-	●	●	●	●	●	-
UE	-	-	●	●	●	●	●	●	-

Nylon tube

Size Type	4x2	4x2.5	6x4	8x6	10x7.5	10x8	12x9	12x10	16x13
NA	-	●	●	●	●	-	●	-	●
NB	-	●	●	●	●	-	●	-	●
FB	-	●	●	●	●	-	●	-	-

Polyolefin tube

Size Type	4x2	4x2.5	6x4	8x5	8x6	10x7.5	10x8	12x9	12x10	16x13
CTA	●	●	●	-	●	●	●	-	●	●
CTB	-	●	●	●	-	●	-	●	-	-

Fluoropolymer tube

Size Type	4x2	4x2.5	6x4	8x6	10x7.5	10x8	12x9	12x10	16x13
SFT	●	●	●	●	●	●	●	●	●
SET	●	●	●	●	●	●	●	●	●

inch

Polyurethane tube

Size Type	1/8 (3.18x2)	5/32* (4x2.5)	3/16 (4.76x2.99)	1/4 (6.35x4.15)	5/16* (8x5)	3/8 (9.53x6.99)	1/2 (12.7x8.5)	5/8* (16x11)
UB	●	●	●	●	●	●	●	●

Nylon tube

Size Type	1/8 (3.18x2)	5/32* (4x2.5)	3/16 (4.76x2.99)	1/4 (6.35x4.15)	5/16* (8x5)	3/8 (9.53x6.99)	1/2 (12.7x9.56)	5/8* (16x13)
NA	●	●	●	●	●	●	●	●
FB	-	●	-	●	●	●	●	-

Polyolefin tube

Size Type	5/32* (4x2)	5/32* (4x2.5)	1/4 (6.35x4.57)	5/16* (8x6)	3/8 (9.53x6.99)	1/2 (12.7x8.5)	5/8* (16x13)
CTA	●	●	●	●	●	●	●
CTB	-	●	● (6.35x4.15)	● (8x5)	● (9.53x5.99)	● (12.7x8.5)	-

Fluoropolymer tube

Size Type	1/8 (3.18x2.18)	5/32* (4x2.5)	1/4 (6.35x4.57)	5/16* (8x6)	3/8 (9.53x6.99)	1/2 (12.7x9.56)	5/8* (16x13)	1 (25.4x22)
SFT	-	●	●	●	●	●	●	-
SET	-	●	●	●	●	●	●	-

* Inch size: 5/32, 5/16, 5/8 are shared with mm sizes.



UB [Polyurethane tube - 10 colors]



- Very flexible and kink resistant, suitable for applications where maneuverability is required and cleaning and packing in cleanroom ISO class 6 equivalent.
- Tube dia. : $\varnothing 1.8 \sim \varnothing 16$ (O.D.), $\varnothing 1 \sim \varnothing 11$ (mm, inch)(I.D.) , tube length : 20, 50, 100 m
- Medium : Air, water (conditional)
- Max. operating pressure : 1.0 MPa (at 20 °C, 65%RH)
- Max. vacuum : -100 kPa
- Operating temp. : Air -20~70 °C (No freezing), water -15~60 °C (No freezing)



UC [Soft polyurethane tube - 6 colors]



- Extreme flexibility allows the installation in in a narrow space where a tight bending radius is required.
- Tube dia. : $\varnothing 4 \sim \varnothing 12$ (O.D.), $\varnothing 2.5 \sim \varnothing 8$ mm (I.D.), tube length : 20, 100 m
- Medium : Air, water (conditional)
- Max. operating pressure : 0.7 MPa (at 20 °C, 65%RH)
- Max. vacuum : -100 kPa
- Operating temp. : Air -20~60 °C (No freezing), water -15~60 °C (No freezing)

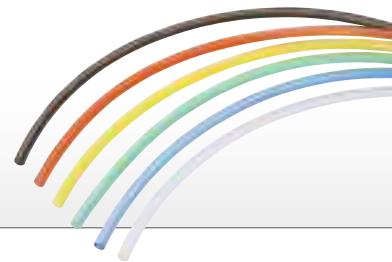

UM [Soft polyurethane tube - 8 colors]



- Extreme flexibility allows the installation in in a narrow space where a tight bending radius is required.
- Tube dia. : $\varnothing 4 \sim \varnothing 16$ (O.D.), $\varnothing 2.5 \sim \varnothing 11$ mm (I.D.), tube length : 20, 100 m
- Medium : Air
- Max. operating pressure : 0.8 MPa (at 20 °C, 65%RH)
- Max. vacuum : -100 kPa
- Operating temp. : -15~60 °C (No freezing)

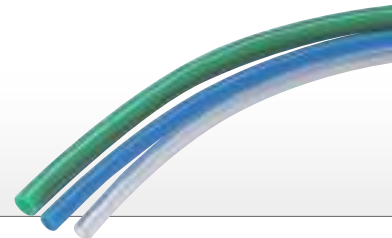

UBT [Dedicated polyurethane tube for air - 2 colors]



- The Ester based polyurethane tube has achieved 20% cost saving compared to Ether based polyurethane tube (UB). Featuring excellent flexibility, suitable where small bending radius is needed.
- Tube dia. : $\varnothing 3 \sim \varnothing 12$ (O.D.), $\varnothing 2 \sim \varnothing 8$ mm (I.D.), tube length : 20, 50, 100 m
- Medium: Air
- Max. operating pressure : 1.0 MPa (at 20 °C, 65%RH)
- Max. vacuum : -100 kPa
- Operating temp. : -20~70 °C (No freezing)

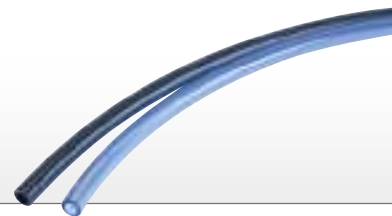

UBS [Low friction polyurethane tube - 5 colors]



- Best suitable for cable/hose protecting and guiding devices, and where small bending radius is required.
- The friction factor is 1/3 of PISCO's most versatile polyurethane tubings (UB)
- Tube dia. : $\varnothing 4 \sim \varnothing 12$ (O.D.), $\varnothing 2.5 \sim \varnothing 8$ mm (I.D.), tube length : 20, 100 m
- Medium: Air
- Max. operating pressure : 1.0 MPa (at 20 °C, 65%RH)
- Max. vacuum : -100 kPa
- Operating temp. : -20~70 °C (No freezing)

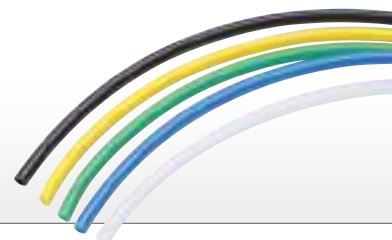

UD [Vacuum tube - 1 color]

-S3

- Very soft and flexible suitable for piping of moving parts.
- Suitable for applications where maneuverability or small bend radius is required.
- Tube dia.: $\varnothing 4 \sim \varnothing 12$ (O.D.), $\varnothing 2.5 \sim \varnothing 9$ mm (I.D.), tube length: 20, 100 m
- Medium: Air
- Max. operating pressure: 0.4 MPa (at 20 °C, 65%RH)
- Max. vacuum: -100 kPa
- Operating temp.: -15~50 °C (No freezing)



NA [Nylon tube - 9 colors]

-S3

- Fine pressure, wear, and cold resistance.
- Excellent bending fatigue resistance. stably usable for long time.
- Tube dia.: $\varnothing 4 \sim \varnothing 16$ (O.D.), $\varnothing 2.5 \sim \varnothing 13$ (mm, inch)(I.D.), tube length: 20, 100 m
- Tube hardness (reference): shore D 65
- Medium: Air, water (Conditional), thermal oil (Conditional)
- Max. operation pressure: 2.0 MPa (at 20°C, 65%RH)
- Max. vacuum: -100 kPa
- Operating temp.: Air -20~100°C (No freezing), water, thermal oil -15~90°C (No freezing)



NB [Soft nylon tube - 12 colors]

-S3

- Fine pressure, wear, and cold resistance. NB tube for hot water and thermal oil.
- Excellent bending fatigue resistance. Stably usable for long time.
- Tube dia.: $\varnothing 4 \sim \varnothing 16$ (O.D.), $\varnothing 2.5 \sim \varnothing 13$ (mm, inch)(I.D.), tube length: 20, 100 m
- Tube hardness (reference): shore D 58
- Medium: Air, water (Conditional), thermal oil (Conditional)
- Max. operation pressure: 1.3 MPa (at 20 °C, 65%RH)
- Max. vacuum: -100 kPa
- Operating temp.: Air -20~100°C (No freezing), water, thermal oil -15~90°C (No freezing)

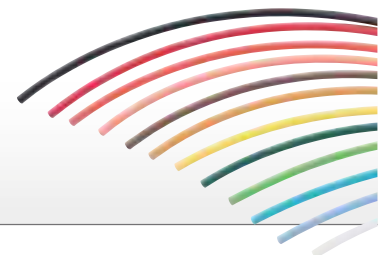

UQ / UCQ [(Soft) Multi-colored ribbon tube - (6)10 colors]

-S3

- Flexible and it is easy tracing and identifying the piping.
- Eliminate tangling issues and enable easy tracing and troubleshooting
- Tube dia.: $\varnothing 3 \sim \varnothing 12$ (O.D.), $\varnothing 2 \sim \varnothing 8$ mm (I.D.), No. of cores: 2~6, Tube length: 20, 100 m
- Medium: Air, water (Conditional)
- Max. operation pressure: 1.0 MPa (UQ), 0.7 MPa (UCQ) (at 20 °C, 65%RH)
- Max. vacuum: -100 kPa
- Operating temp.: Air -20~60 °C (No freezing), water -15~60 °C (No freezing)



UMQ [Multi ribbon tube - 1 color]

-S3

- Suitable for double-acting and multi-acting equipment, providing air supply.
- Tube dia.: $\varnothing 4 \sim \varnothing 12$ (O.D.), $\varnothing 2.5 \sim \varnothing 8$ mm (I.D.), No. of cores: 2~6, Tube length: 10 ~ 100 m
- Medium: Air
- Max. operation pressure: 0.8 MPa (at 20 °C, 65%RH)
- Max. vacuum: -100 kPa
- Operating temp.: -15~60 °C (No freezing)





UL / NL [Spiral coiled polyurethane / Nylon tube - 10/9 colors]

-S3

- Suitable for piping for air guns, air-powered screwdrivers and so on.
- The piping of movable part is completed in a small space without distorting the joints.
- UL: polyurethane (UB) processed into coil, NL: Excellent resilience nylon tube (NA) machined into coils.
- Tube dia.: $\varnothing 3 \sim \varnothing 12$ (O.D.), tube length before coiling: 1 ~ 20 m
- Medium: Air, water (conditional)
- Max. operation pressure: 1.0 MPa (UL), 2.0 MPa (NL) (at 20 °C, 65%RH)
- Max. vacuum: -100 kPa
- Operating temp.: UL: -20~60 (Air), -15~60 °C (Water)(No freezing),
NL: -20~90 (Air), -15~90 °C (Water)(No freezing)

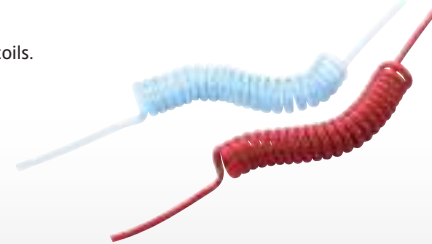

UML [Spiral coiled tube - 8 colors]

-S3

- Suitable for piping for air guns, air-powered screwdrivers and so on.
- The piping of movable part is completed in a small space without distorting the joints.
- UM: polyurethane (UB) processed into coil.
- Tube dia.: $\varnothing 4 \sim \varnothing 12$ (O.D.), tube length before coiling: 1 ~ 20 m
- Medium: Air
- Max. operation pressure: 0.8 MPa (at 20 °C, 65%RH)
- Max. vacuum: -100 kPa
- Operating temp.: -15~60 °C (No freezing)



ULF [Twin spiral coiled tube - 10 colors]

-S3

- Double tube coiled tubing is ideal for application where repeat-bending and twisting is required.
Flexible polyurethane (UB).
- Tube dia.: $\varnothing 3 \sim \varnothing 12$ (O.D.), tube length before coiling: 1 ~ 10 m
- Medium: Air, water (conditional)
- Max. operation pressure: 1.0 MPa (at 20 °C, 65%RH)
- Max. vacuum: -100 kPa
- Operating temp.: Air -20~60 °C (No freezing), water -15~60 °C (No freezing)

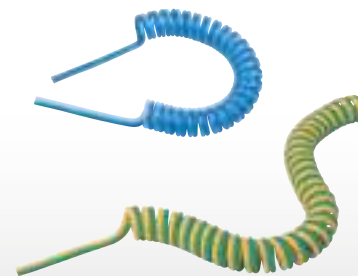

UMLF [Twin spiral coiled tube - 8 colors]

-S3

- Double tube coiled tubing is ideal for application where repeat-bending and twisting is required.
- Tube dia.: $\varnothing 4 \sim \varnothing 12$ (O.D.), tube length before coiling: 1 ~ 10 m
- Medium: Air
- Max. operation pressure: 0.8 MPa (at 20 °C, 65%RH)
- Max. vacuum: -100 kPa
- Operating temp.: -15~60 °C (No freezing)

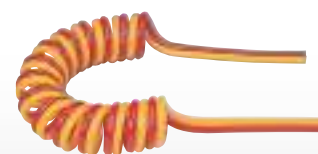

SFT [Fluoropolymer (PFA) tube - 5 colors]



- Excellent in chemical and weather resistance. Good for use in chemical, food, medical and semi-conductor industries.
- Extruded from fluoropolymer (PFA) which is excellent in chemical resistance. Superior interior surface smoothness, transparency and purity.
- Inch size models, perfect to be used with the inch-sized SUS316 compression fitting are prepared.
- Tube dia: $\varnothing 4 \sim \varnothing 16$ (O.D.), $\varnothing 2 \sim \varnothing 13$ (mm, inch)(I.D.)
- Tube length: 5m, 20m, 50m, 100m
- Medium: Air, water, others such as chemicals (Conditional)
- Max. operating pressure: 2.4 MPa (at 20°C, 65%RH)
- Max. vacuum: -100 kPa
- Operating temp.: Air -65~260°C (No freezing)

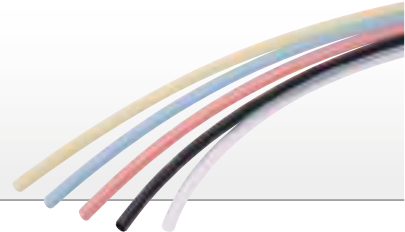

SET [Fluoropolymer (FEP) tube - 5 colors]



- Superior chemical resistance makes Fluororesin Tube best suited for chemical, food-processing, medical care and semiconductor applications.
- Achieved 44% cost reduction compared with Pisco SFT tube series. Extensive service temperature range.
- Inch size models, perfect to be used with the inch-sized SUS316 compression fitting are prepared.
- Tube dia: $\varnothing 4 \sim \varnothing 16$ (O.D.), $\varnothing 2 \sim \varnothing 13$ (mm, inch)(I.D.)
- Tube length: 5m, 20m, 50m, 100m
- Medium: Air, water, others such as chemicals (Conditional)
- Max. operating pressure: 2.7 MPa (at 20°C, 65%RH)
- Max. vacuum: -100 kPa
- Operating temp.: Air -65~200°C (No freezing)

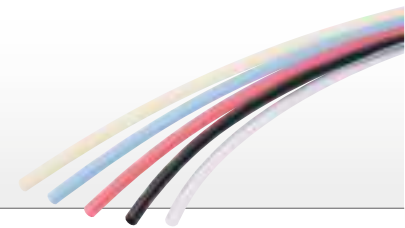

CTA [Polyolefin tube - 6 colors]



- Suitable for application requiring sufficient flow rate under clean environment. Adopting a polyolefin type resin suitable for clean environment.
- Superior water resistance.
- Cleaning and packing in cleanroom ISO class 6 equivalent.
- Tube dia: $\varnothing 4 \sim \varnothing 16$ (O.D.), $\varnothing 2 \sim \varnothing 13$ mm (I.D.) , Tube length: 20m, 100m
- Medium: Air, Water, Others such as chemicals (Conditional)
- Max. operating pressure: 1.0 MPa (at 20°C, 65%RH)
- Max. vacuum: -100 kPa
- Operating temp.: -15~80°C (No freezing)

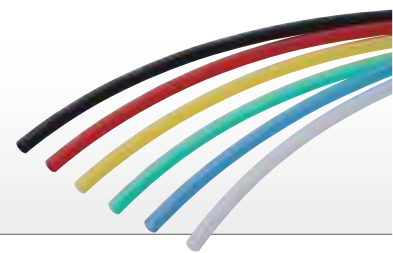

CTB [Soft polyolefin tube - 6 colors]



- Suitable for application requiring sufficient flow rate under clean environment. Adopting a polyolefin type resin suitable for clean environment.
- Superior water resistance.
- Cleaning and packing in cleanroom ISO class 6 equivalent.
- Tube dia : $\varnothing 4 \sim \varnothing 12.7$ (O.D.) · $\varnothing 2.5 \sim \varnothing 8.5$ mm (I.D.), tube length : 20m, 100m
- Medium : Air, water, others such as chemicals (Conditional)
- Max. operating pressure : 0.8 MPa (at 20°C, 65%RH)
- Max. vacuum : -100 kPa
- Operating temp. : -15~80°C (No freezing)

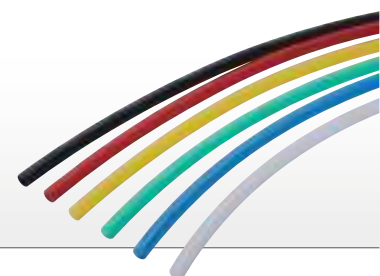



FB [Anti-spatter - 1 color]

-S3

- Covered with flame-retardant resin UL-94 (V-0 equivalent) exhibits an excellent spatter resistance.
- Can also be used with hot water and thermal oil.
- Tube dia : $\varnothing 6 \sim \varnothing 14.7$ (Cover O.D.) $\varnothing 4 \sim \varnothing 12.7$ (O.D.), $\varnothing 2.5 \sim \varnothing 9.56$ (mm, inch)(I.D.)
- Tube length : 20m, 50m, 100m
- Medium : Air, water, thermal oil (Conditional)
- Max. operating pressure : 1.0 MPa (at 20°C, 65%RH)
- Max. vacuum : -100 kPa
- Operating temp. : -15~90°C (No freezing)



UE [Anti-static (ESD) tube - 1 color]

-S3

- Polyurethane based ESD (anti-static) tubing.
Best suited for use on manufacturing or assembly line that requires dissipation of static electricity and prevention of electrification.
- Tube dia: $\varnothing 3 \sim \varnothing 12$ (O.D.), $\varnothing 2 \sim \varnothing 8$ mm (I.D.)
- Tube length : 20m, 100m
- Medium : Air
- Surface resistance : $-1.4 \times 10^3 \Omega \cdot \text{cm}$
- Max. operating pressure : 0.6 MPa (at 20°C, 65%RH)
- Max. vacuum : -100 kPa
- Operating temp. : -15~40°C (No freezing)



MEMO

TCN -15 [Tube shears]

- Cut tube smoothly.
- Sharp edge and excellent in durability.
- Tube dia (O.D.) : $\varnothing 3 \sim \varnothing 16$ mm · $\varnothing 1/8 \sim \varnothing 5/8$ inch



TC-21 [Tube cutter]

- The blade has two cutting edges. Change the cutting edge by rotating the blade 180 degree.
- Tube can be cut to required length because of built-in tape measure (1m).
- The tube cutting plane becomes right angled and fine because of the tube guide.
- The lock mechanism keeps the cutter safely locked.
- Tube cutter blade (TC-C).



TSC [Spatter tube remover]

- Peeling only the flame retardant cover of PISCO antisplatter tube (FB tube) like sharpening a pencil.
- No damage to the inner tube.
- The transparent cover enables to check cutting progress easily.
- Tube dia (O.D.) : $\varnothing 4 \sim \varnothing 12$ mm



- Tube can be cut to required length because of built-in tape measure (1 m)



TSC
Operational
Video





TR [Tube reel]

- Easy to supply and change tube.
- 4 Width selections according to tube sizes.
- The reel is reusable to reduce waste. Material of the reel is all plastic.
- Applicable Tube dia. : $\phi 4 \sim \phi 16$ mm · $\phi 1/8 \sim \phi 1/2$ inch
- Operating temp. : $-10 \sim 50^{\circ}\text{C}$



ULT / PCT

[Coiling tube with twist-proof fitting]

- Avoid twisted tube problem for air tool.
- Fittings built-in at both tube end.
- Tube O.D. : $\phi 8$, Thread size : R1/4, Rc1/4
- Tube length : 2.5, 5, 7.5, 10m
- Medium : Air
- Max. operating pressure : 0.9 MPa (20°C , 65%RH)
- Max. vacuum : -100 kPa
- Operating temp. : $0 \sim 60^{\circ}\text{C}$ (No freezing)

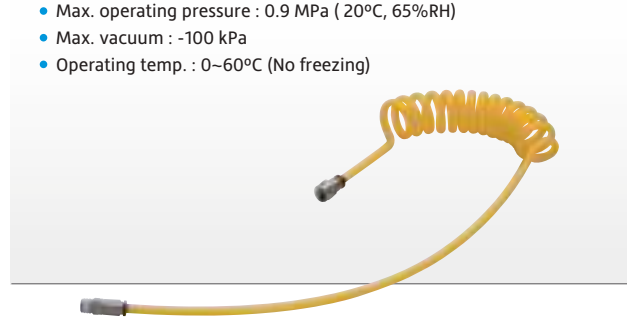

WR [Insert ring]

- Protect tubes from deformation.
- Ultra soft tube is connectable to fitting.
- Necessary for the connection with push-in fitting, when fluid medium is water.
- Tube dia. : $\phi 3 \times 2 \sim \phi 16 \times 13$ mm · $\phi 3/16 \sim \phi 1/2$ inch



TB [Tube binder]

- Bind a plurality of tubes by clamping it.
- Fixable on wall with fixing holes. Fixing hole is removable when unnecessary.
- Number of bound tubes : 2, 3, 4
- Tube dia (O.D.) : $\phi 4 \sim 12$





ISO Compliant



Variety of Styles



High Quality



Environmental Protection



Special Environment



Clean Environment

Change Valve PISCO®

- Change valve | Change valve
- Shut-off valve | Hand valve, Ball valve, Ball valve SUS304, Ball valve SUS316 equivalent
- Push-type valve | Mechanical valve

-S3 No copper-based material is used (standard) **OIL** Oil-free

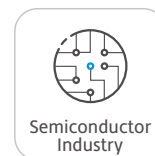

Semiconductor Industry



Food Industry

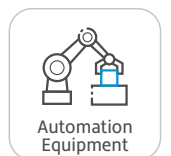

Automation Equipment



Pharmaceutical Industry

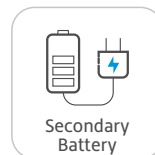

Secondary Battery



Chemical Industry

HBV [Change valve - Three-way]

- Changeover air direction by 90°. Fine operability and easy changeover.
- Lightweight and compact design.
- Medium : Air
- Max. operating pressure : 0.7 MPa
- Max. vacuum : -100 kPa
- Operating temp. : 0~60°C (No freezing)
- Tube dia. : (mm) ø6, 8, 10, 12 mm
(inch) ø1/4, 5/16, 3/8, 1/2 inch



Video Introduction

HV [Hand valve]

- Hand Valve turns on and off air pressure to pneumatic devices.
- Three-directional control valve, which discharges the residual pressure, and two-directional control valve is available.
- Medium: Air • Max. operating pressure : 1.0 MPa
- Max. vacuum : -100 kPa
- Operating temp. : 0~60°C (No freezing)
- Tube dia. : (mm) ø4, 6, 8, 10, 12 mm
(inch) ø3/16, 1/4, 5/16, 3/8, 1/2, 5/32 inch
- Thread size : R1/8, 1/4, 3/8, 1/2 · NPT1/8, 1/4, 3/8, 1/2



Video Introduction

BV [Ball valve]

- Ensure Effective area for variety of tube dia. control open/close air supply.
- Easily adjustable lever with scale for 10 series
- PPS Material for 20/60 Series. Water can be used.
- Medium : Air, water (Conditional)
- Effective area : 10, 20, 60 mm²
- Max. operating pressure : 0.9 MPa
- Max. vacuum : -100 kPa
- Operating temp. : 0~60°C (No freezing)
- Tube dia. : (mm) ø3, 4, 6, 8, 10, 12 mm
(inch) ø1/8, 5/32, 1/4, 5/16, 3/8, 1/2 inch
- Thread size : R1/8, 1/4, 3/8, 1/2



Video Introduction

BV* - SUS [Ball valve SUS304]

- Corrosion resistant ball valve ideal for use in special environments.
- SUS304 is used for the metal material. FKM is used for the seal material.
- Medium: Air, water, others (Conditional)
- Effective area : 20, 60 mm²
- Max. operating pressure : 0.9 MPa
- Max. vacuum : -100 kPa
- Operating temp. : 0~80°C (No freezing)
- Tube dia. : (mm) ø6, 8, 10, 12 mm, (inch) ø1/4, 5/16, 3/8, 1/2 inch
- Thread size : R1/8, 1/4, 3/8, 1/2



-S3

NSB* / SSPC

[Ball valve SUS316 equivalent]

- SUS316 equivalent material (SUS316 or CF8M) for fluid contact part. Chemical and mixed gas can be used as fluid medium. 1 piece, reduced bore type.
- Medium : Air, Inert gas such as nitrogen/helium (no toxic), water/liquid (Conditional), others such as chemicals (Conditional)
- Max. operating pressure : 6.9 MPa
- Max. vacuum : -101 kPa
- Operating temp. : -29~232°C (No freezing)
- Tube dia. : ø4, 6, 8, 10, 12, 16 mm
- Thread size : Rc1/4, 3/8, 1/2



-S3

OIL

MV* [Mechanical valve]

- This push-type valve turns on and off the input of air pressure. The operating force is not affected by the strength of air pressure owing to the spool valve mechanism.
- The three-directional control valve exhausts residual pressure when closed.
- Medium : Air • Operating pressure : 0~0.7 MPa
- Max. vacuum : -101 kPa
- Operating temp. : 0~60°C (No freezing)
- Tube dia. : (mm) ø4, 6 mm, (inch) ø1/8, 5/32 inch



Video Introduction



Low Wear



Space Saving

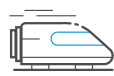

High Speed And Stability



Low Noise



Longevity



Pipeline Integration

Plarailchain PISCO®

- Flaps open and closed | HPU, HPO (full-covered open-close flap type), HPE (open-close split flap type), HPC (low noise type)
- Flaps fixed | HPK (no flap type), HPM (full-cover type)
- Low abrasion and low noise | SP, SPO (low abrasion, low noise, full-covered open-close flap type), SD (high durability, low abrasion)
- Minimum dust ejection | SC (low abrasion, low noise), SCL (low abrasion, low noise, space saving)
- Operating environment | Avoid using in acid/alkaline atmosphere or in hot water.

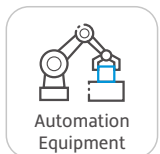

Automation
Equipment

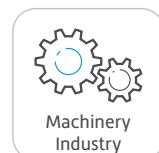

Machinery
Industry



New Energy
Industry

 Products that generate less dust

HPU [Open-close flap type]

- The specially designed flaps, opening on either side, facilitate replacement or additional of cables. You can check the cables with the flaps down in place.
- Excellent in safety, durability, smooth movement and easy operation. Capable of following every linear motion and any.
- Bending radius (R) : 19 ~ 200 mm
- Max. cable / Tube dia. O.D.: 7, 11, 19, 36 mm
- Pitch : 20, 25, 32, 45, 70 mm
- Service temp. : -10~80°C



HPO [Full-covered open-close flap type]

- The full-enclosing type protects cables well by preventing entry of dust.
- The flaps can be opened on either side. The specially designed flaps, opening on either side, facilitate replacement or additional of cables.
- Bending radius (R) : 30 ~ 400 mm
- Max. cable / Tube dia. O.D. : 10, 20, 36, 46 mm
- Pitch: 20, 26, 45, 60, 90 mm
- Service temp. : -10~80°C



HPE [Open-close split flap type]

- Cables can be sorted and accommodated into two compartments.
- The interior space comprises two halves, each of which has its own flaps. The cables can be divided by the type. The flaps of only one side can be opened for replacement of cables there.
- Bending radius (R) : 50 ~ 200 mm
- Pitch : 19 mm
- Pitch : 45 mm
- Service temp. : -10~80°C

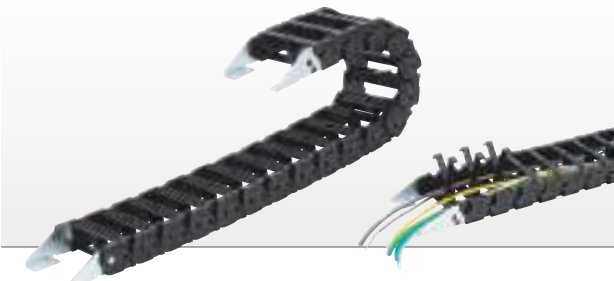

HPC [Low noise type]

- Applying smaller block compositions and special engineering plastics contribute to the low noise.
- The flaps break open in the middle, so that you can add or remove cables simply by pushing in or pulling out.
- Bending radius (R) : 30 ~ 150 mm
- Max. cable / Tube dia. O.D. : 16, 19, 23, 24, 28, 31 mm
- Pitch : 25, 32, 45 mm
- Service temp. : 0~50°C

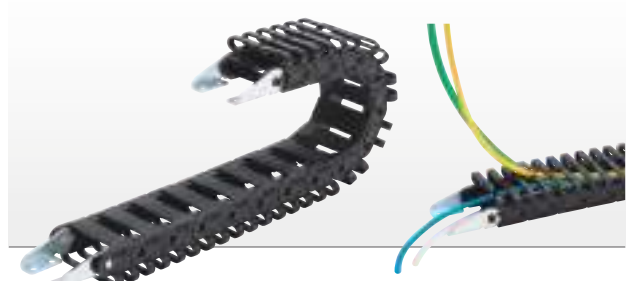

HPK [No flap type]

- Simple one-piece design and cost effective cable carrier.
- The smaller sizes of the series which store even just one cable are available.
- Inner cables can be checked from outside.
- Simple one-piece design and cost effective cable carrier.
- Bending radius (R) : 19 ~ 50 mm
- Max. cable / Tube dia. O.D. : 7, 12 mm
- Pitch: 20, 25, 32 mm
- Service temp. : -10~80°C



HPM [Full-cover type]

- Simple one-piece design, cost effective, fully-enclosed cable carrier.
- Cost effective and suitable for mass-production machineries.
- Simple design, cost effective, fully-enclosed.
- Bending radius (R) : 28 ~ 50 mm
- Max. cable / Tube dia. O.D. : 13, 14 mm
- Pitch: 15, 22 mm
- Service temp. : -10~80°C





SP [Low abrasion, low noise, open-close flap type]

- The cable carrier made of special plastic realizes less abrasive wear on cables/tubings in the carrier. Special resin reduces abrasive wear on cables to around one-fourth or one-fifth of other carriers.
- Best suitable for the environment where static electricity should be dissipated.
- Bending radius (R) : 30 ~ 400 mm
- Max. cable / Tube dia. O.D.: 12, 16, 20, 28, 34, 36, 44, 60, 64 mm
- Pitch : 25, 32, 36, 43.3, 62.5, 67, 91, 100 mm
- Service temp. : -10~80°C



SPO [Low abrasion, low noise, full-covered open-close flap type]

- The cable carrier (full enclosing type) made of special plastic realizes less abrasive wear on cables/tubings in the carrier. Special resin reduces abrasive wear on cables to around one-fourth or one-fifth of other carriers.
- Compared with conventional carriers, the carrier reduces abrasive wear on the cables, hoses in it.
- The flap opens from both sides along the outer radius as well as inner radius.
- Bending radius (R) : 125 ~ 250 mm
- Service temp. : -10~80°C
- Max. cable / Tube dia. O.D. : 36, 44 mm
- Pitch : 67, 91 mm



SD [High durability, Low abrasion, open-close flap type]

- Can be used for high-speed, high-load drive units.
- The load is distributed by strengthening the joint structure.
- Reduced behavior change. The pitch between link connections has been minimized to achieve smooth operation. Long service life by suppressing splashing during operation and stop.
- Bending radius (R) : 50 ~ 100 mm
- Max. cable / Tube dia. O.D. : 20 mm
- Service temp. : -10~80°C
- Pitch : 25 mm



CC [Cable clamp & dividing sheet shelf]

- Easy to fasten and divide the interior cables/tubings. Place cables and tubings along comb-teeth of a cable clamp plate and fasten them with cable ties.
- To reduce drawn-in or protruded cables which may cause wear and tear.
- By using spacers, cables and tubes can be organized into double tier.
- Reduce wear between cables and tubes.
- 7 types, from 4 to 10 comb-teeth, are available according to the plate width.
- Service temp. : -10~80°C

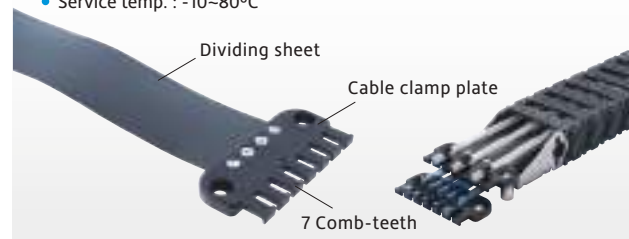

SC · SCL [Min. dust ejection, low noise, open-close flap, hinge connection type]

- The connecting construction (snap-together) that is free from sliding part minimizes the generation of dust
- Link-against-link friction noise, which is generated when links are traveling, is significantly reduced, thanks to use of soft material of low percussive noise.
- The structure of a hard material frame combined with a soft material frame prevents rigidity reduction, which is incidental to soft material based products.
- Flaps are made of same material as Plarailchain SP series, making it possible to further increase rigidity while decreasing cable abrasion. The flap opens at both sides. It is also removable.
- Bending radius (R) : 28 ~ 115 mm
- Max. cable / Tube dia. O.D.: 12, 16, 20, 24, 28 mm
- Pitch : 18, 20, 30, 45 mm
- Service temp. : -8~80°C

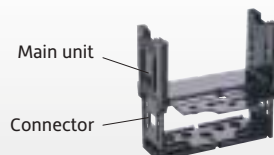



Lightweight



Variety of Styles



Space Saving



General Environment



Special Environment



High Quality

Auxiliary Equipment

Product item | Floating joint / Rod ends / Shock absorbers / Cable with connector / Connector / Jet cooler / Flow control valve / Quick exhaust valve / Shuttle valve / Silencer throttle valve / Check valve / Silencer / Pilot check valves / Hydraulic speed controllers / Polyurethane tube (PU tube) / Stainless fitting / Coupler / Pneumatic presses



Machinery Industry



Food Industry



Automation Equipment



New Energy Industry



Automotive Industry



Machine Tool

MFC series [Floating Joint]

- Applicable cylinder tube I.D. $\phi 6 \sim 160$ mm
- Rotation angle $\pm 5^\circ$
- The shaft alignment time for the error tolerance connects between two shafts can be finished and installed easily, even the newcomer can do also.
- Thread size : M3, M4, M5, M6, M8, M10, M12, M14, M16, M18, M20, M22, M24, M26, M27, M30, M36, M39, M40, M45, M50



MFCS series [Floating Joint]

- Applicable cylinder tube I.D. $\phi 6 \sim 32$ mm
- Rotation angle $\pm 5^\circ$
- The shaft alignment's time for the error tolerance connects between two shafts can be finished and installed easily, even the newcomer can do also.
- Thread size : M3, M4, M5, M6, M8, M10



MDSC series

[Shock absorbers]

- Non-adjustable (Self compensation)
- Thread size : M8 \times 1 ~ M36 \times 1.5
- Stroke : 6~60 mm
- Max. Nm per cycle : 1.8~260 Nm
- Max. impact speed : 0.8~4 m/s



PHS series [Rod ends]

- Dia. A : $\phi 5 \sim 30$ mm
- Female thread size : M5~M30
- Copper lining structure embedded.
- Carbon steel body.
High carbon chromium bearing steel.

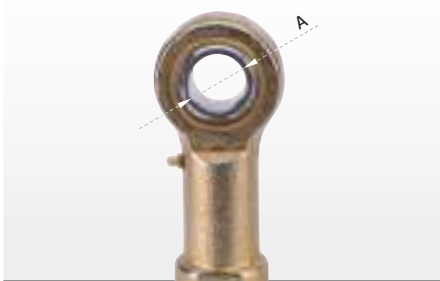

PHS-S series [Rod ends]

- Dia. A : 5~20 mm
- Female thread size : M4~M20
- Embedded bearing structure.
- Stainless steel body.
Sintered bronze bush.



MDFC series

[Shock absorbers]

- Adjustable
- Thread size : M14 \times 1 ~ M36 \times 1.5
- Stroke : 10~50 mm
- Max. Nm per cycle : 15~220 Nm
- Max. impact speed : 3.2 m/s



MAC series

[Shock absorbers]

- Self compensation
- Thread size : M8 \times 1 ~ M36 \times 1.5
- Stroke : 6~80 mm
- Max. Nm per cycle : 2~250 Nm
- Max. impact speed : 0.5~4 m/s



MAD series

[Shock absorbers]

- Adjustable
- Thread size : M14 \times 1/1.5 ~ M64 \times 2
- Stroke : 10~150 mm
- Max. Nm per cycle : 20~3600 Nm
- Max. impact speed : 1.5~4.5 m/s



MACD series

[Shock absorbers]

- Dual-side buffering
- Thread size : M20 \times 1.5
- Stroke : 30~50 mm
- Max. Nm per cycle : 45~60 Nm
- Max. impact speed : 1~3.5 m/s





M83R-F series

[Cable with connector]

- Number of contacts : 3
- Rated voltage/current : DC/AC125V / 3A
- Material: Brass (Au plating), contact bearer : PVC
- Spec. : M8 (male) – M8 (female)

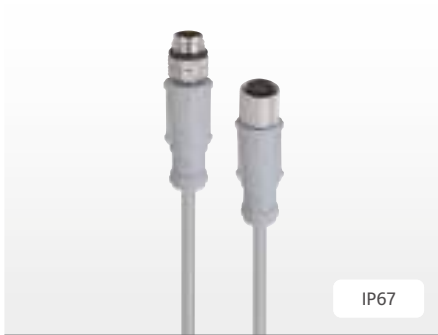

M125R-WB series

[Cable with connector]

- Number of contacts : 5
- Rated voltage/current : DC/AC125V / 3A
- Material: Brass (Au plating), contact bearer : PVC
- Spec. : M12 (female)

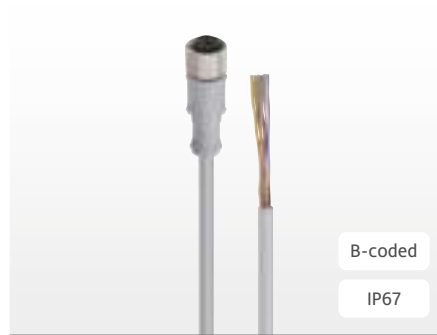

M124R-FA series

[Cable with connector]

- Number of contacts : 4
- Rated voltage/current : DC/AC125V / 3A
- Material: Brass (Au plating), contact bearer : PVC
- Spec. : M12 (male) – M12 (female)



M124R-RJD series

[Communication cable Ethernet/IP]

- Number of contacts : 4, 8
- Rated voltage/current : DC/AC30V / 0.5A
- Material: Brass (Au plating), contact bearer : PVC
- Spec. : M12 (male) – RJ45



M124R-MD series

[Communication cable Ethernet/IP]

- Number of contacts : 4
- Rated voltage/current : DC/AC30V / 0.5A
- Material: Brass (Au plating), contact bearer : PVC
- Spec. : M12 (male) – M12 (male)



M83/84/88 series

[Cable with connector]

- Number of contacts : 3, 4, 8
- Rated voltage/current : DC/AC60V/3A, DC30V/1.5A
- Material : Brass (Au plating), contact bearer : PP, PA
- Spec. : M8 (female)



M83C-M series

[Connector]

- Number of contacts : 3
- Rated voltage/current : DC/AC60V / 5A
- Housing material : Nylon
- Spec. : M8 (male)



M124C-M series

[Connector]

- Number of contacts : 4
- Rated voltage/current : DC/AC250V / 4A
- Housing material : Nylon
- Spec. : M12 (male)





MJC series

- Jet out cooler air maximum 60°C lower than the inlet air only by supplying compressed air.
- Uses the theory of vortex, no moving parts are used in the construction, hence long life sustainability.
- Does not require coolant or an electrical source, utilises the high speed flow of compressed air for generating cool air from hot air.
Ideal for applications where rapid cooling is required, e. g., spot welding.
- Can produce consistent supply of cool air even when the supply is in 40 Degrees C.
By changing air consumption you can simply change the cooling temperature.

Model	Cool air out port	Max. temp. drop °C	Operating pressure MPa
MJC-150K	1/8	60	0.3~0.7
MJC-300K	1/4	60	0.3~0.7
MJC-450K	3/8	60	0.3~0.7
MJC-600K	3/8	60	0.3~0.7

Flow Control Valve



MSC series

Model	Port size	Flow ℓ / min		Number of needle rotations	Operating pressure MPa
		Free	Controlled		
MSC100	M3×0.5, M5×0.8	20, 90	20, 80	6, 8	0.1~0.7
MSC201	1/8, 1/4	110, 140	180, 220	8	0~1
MSC300	3/8, 1/2	300, 400	500, 520	8	0~1
MSC500	1/2, 3/4	5771, 6697	6316, 8384	–	0~1
MSC600	3/4, 1	8221, 14047	8929, 12522	–	0~1

Quick Exhaust Valve



MVQE series

- This unit makes it possible to achieve increased piston speeds on the exhaust stroke for single acting and double acting cylinders.

Model	Port size	Effective orifice mm ²		Operating pressure MPa
		IN → OUT	OUT → EXH	
MVQE100	1/8	9	19	0.1~1
MVQE300	1/4, 3/8	24, 25	31, 33	0.1~1
MVQE301	3/8, 1/2	60, 110	70, 110	0.1~1
MVQE400	1/2	46	46	0.1~1
MVQE501	3/4, 1	135, 176	180, 187	0.1~1



MVAS series

[Shuttle valve]

- Port size : 1/8, 1/4
- Operating pressure : 0.1~1 MPa
- Effective orifice : 11.5, 30.5 mm²
- This valve has two input inlets (E1,E2) and can be controlled in different position. First activated position can get through to output signal (A).



MSLC2 series

[Silencer throttle valve]

- Port size : 1/8, 1/4, 3/8, 1/2
- Operating pressure : 0.1~0.7 MPa



MJBV series

[Check valve]

- Port size : 1/8, 1/4, 3/8, 1/2
- Operating pressure : 0.1~0.7 MPa



MSL series

[Brass silencer]

- Port size : M5, 1/8, 1/4, 3/8, 1/2, 3/4, 1



MSLT series

[Plastic silencer]

- Port size : 1/8, 1/4, 3/8, 1/2, 3/4, 1
- Operating pressure : 0~0.9 MPa



MSLE series

[Plastic silencer]

- Port size : 1/8, 1/4, 3/8, 1/2, 3/4, 1
- Operating pressure : 1 MPa
- Significant noise reduction & high air flow.
- High chemical resistance & Rust free.



MSR series

[Plastic silencer]

- Port size : 1/8, 1/4, 3/8
- Operating pressure : 0~0.9 MPa



MPC series

[Pilot check valve]

- Port size : 1/8, 1/4, 3/8
- Operating pressure : 0.05~0.95 MPa
- Effective orifice : 24, 79 mm²
- Maintains pressure in event of air failure.
- Prevents leakage in an air system.



MEF300 series

[Exhaust cleaner]

- Port size : Rc3/8
- Operating pressure : 0~0.9 MPa
- Filter element : 6 μm
- The MEF300 can remove oil mist and dust in exhaust air for keeping environment clean.



MHR series

- Hydraulic speed controllers are ideal for all kind of cutting tools on machines which need continuous, stable feeding speed.
- Completely sealed construction with anti-dust function to prevent oil leakage, perfect for using in special environment.
- Feeding speeds freely are variable, with reverse travel using powerless springs.
- Small size, easy to install, suitable for robot drilling equipments, conveyor lines, pneumatic tools, woodworking equipments, grinding and cutting machines.



Model	Max. stroke mm	Max. load kgf
MHR-15	15	15~350
MHR-30	30	15~350
MHR-60	60	15~350
MHR-80	80	15~350
MHR-100	100	15~350
MHR-3160	60	30~420
MHRT-60	60	15~350
MHRT-100	100	15~350

Stainless Fitting

MNS* series

- All materials are made of SUS304 / SUS316, which is highly resistant to corrosion, making this series suitable for not only chemical industries but also for airtight special environments (Medical, semiconductor, food, etc.)
- The tube insert part is tightened by a cap nut, ensuring a tight and stable tube.



Model	Type	Tube dia.O.D. mm	Thread size R/Rc	Working vacuum in.Hg (kPa)
MNSC	Straight	4~12, 1/4, 5/16, 3/8, 1/2	1/8, 1/4, 3/8, 1/2	-29.8 (-100)
MNSL	Elbow	4~12, 1/4, 5/16, 3/8, 1/2	1/8, 1/4, 3/8, 1/2	-29.8 (-100)
MNSU	Union straight	4~12, 1/4, 5/16, 3/8, 1/2	-	-29.8 (-100)
MNSV	Union elbow	4~12, 1/4, 5/16, 3/8, 1/2	-	-29.8 (-100)
MNSE	Union tee	4~12, 1/4, 5/16, 3/8, 1/2	-	-29.8 (-100)

Coupler

MS* / MP* series

- Material : Steel, Brass



Model		Type	Thread size	Hose size	PU size I.D.×O.D.
Socket	Plug				
MSM	MPM	Male screw	R1/4, 3/8, 1/2	-	-
MSF	MPF	Female screw	Rc1/4, 3/8, 1/2	-	-
MSH	MPH	Hose screw	-	5/16, 3/8, 1/2" Hose	-
MSP	MPP	Nut style	-	-	5×8, 6.5×10, 8×12



High Strength



High Torque



Easy to Maintain



Space Saving



Quick Installation



Longevity

Hydraulic Cylinder

- Compact | Short stroke and compact body design minimizes total length.
- Round | MDO* series with magnetic piston allows sensors to be used.
- Rotary | The body is manufactured in anodized aluminium alloy
- Lever-type | Lever type clamp cylinder gives high clamping force. Carbon steel body ensures long life of unit.
- Swing clamp | Compact design. Available in both clockwise and anti clockwise movement.
- Thread-body | Simple construction, high strength unit ideal for pushing heavy loads.
- Work support | Hydraulic work support is used to both minimise vibration during machining and offer increased support.



Agricultural Machinery



Construction Industry



Automotive Industry



Marine Fisheries



Machinery Industry



Heavy Machinery



MDH* series [Double acting]

Model	Double acting & Type	Tube I.D. mm	Stroke mm	Max. operating pressure MPa
MDHB	Standard type	40, 50, 63, 80, 100, 125, 150	50~1900	14
MDHD	Double rod type	40, 50, 63, 80, 100, 125, 150	50~1900	14
MDHN	Adjustable forward stroke cylinder	40, 50, 63, 80, 100, 125, 150	50~1900	14

MDM* series [Double acting - with magnet]

Model	Double acting & Type	Tube I.D. mm	Stroke mm	Max. operating pressure MPa
MDMB	Standard type	40, 50, 63, 80, 100	50~500	7
MDMD	Double rod type	40, 50, 63, 80, 100	50~500	7
MDMN	Adjustable forward stroke cylinder	40, 50, 63, 80, 100	50~500	7

Compact Hydraulic Cylinder



MHCB / MHCQ series

- Short stroke and compact body design minimizes total length.
- The cylinder barrel is manufactured from anodised aluminium alloy. Internal wall is specially treated, featuring maximum smoothness and long service.
- High quality and durability.

Model	Type	Tube I.D. mm	Stroke mm	Max. operating pressure MPa
MHCB	Single rod / Front mounting	20, 25, 32, 40, 50, 63, 80	30~100	14
MHCB-D	Double rod / Front mounting	20, 25, 32, 40, 50, 63, 80	30~100	14
MHCB-DA/B	Double rod / Adjustable stroke	20, 25, 32, 40, 50, 63, 80	30~100	14
MHCQ	Single rod / Side mounting	20, 25, 32, 40, 50, 63, 80	30~100	14
MHCQ-D	Double rod / Side mounting	20, 25, 32, 40, 50, 63, 80	30~100	14
MHCQ-DA/B	Double rod / Adjustable stroke	20, 25, 32, 40, 50, 63, 80	30~100	14



MHCB-M series [With magnet]

- Compact body design makes overall length to the minimum.
- Honed cylinder inner barrel ensures smooth and consistent piston movement.
- High quality materials are used throughout construction.

Model	Type	Tube I.D. mm	Stroke mm	Max. operating pressure MPa
MHCB-M	Front mounting	32, 40, 50, 63, 80	5~50	7
MHCB-MZ	Front mounting / Male thread	32, 40, 50, 63, 80	5~50	7



MHCB* series [Manifold type]

- Short stroke and compact body design minimizes total length.
- The cylinder barrel is manufactured from anodised aluminium alloy. Internal wall is specially treated, featuring maximum smoothness and long service.
- High quality and durability.

Model	Mounting / Type	Tube I.D.	Stroke	Max. operating pressure
		mm	mm	MPa
MHCBR	Front / Axial front manifold type	20, 25, 32, 40, 50, 63, 80	30~50	14
MHCBF	Front / Axial back manifold type	20, 25, 32, 40, 50, 63, 80	30~50	14
MHCBS	Side / Manifold type	20, 25, 32, 40, 50, 63, 80	30~50	14
MHCBS-D	Side / Manifold type / Double rod	20, 25, 32, 40, 50, 63, 80	30~50	14
MHCBS-DA/B	Side / Adjustable stroke / Double rod	20, 25, 32, 40, 50, 63, 80	30~50	14

Round Hydraulic Cylinder



MDO* series [With magnet]

- Hydraulic cylinder with magnetic piston allows sensors to be used.

Model	Type	Tube I.D.	Stroke	Max. operating pressure
		mm	mm	MPa
MDOC	Pivot type	20, 32	25~300	3.5
MDOA	Front nose mounting type	20, 32	25~300	3.5
MDOD	Double rod type	20, 32	25~300	3.5
MDON	Adjustable forward stroke type	20, 32	25~300	3.5

Hydraulic Rotary Actuator



MRPH series [With magnet]

- The body is manufactured in anodized aluminium alloy, and has been designed looking at the harmonious aesthetic development.
- Pinion and rack made of carbon steel reduce backlash within the mechanism.
- Rotation adjustment screw.

Model	Type	Tube I.D.	Rotation	Max. operating pressure
		mm	°	MPa
MRPH	Male pivot gear	32, 40	90, 180±5	3.5



MHCK series

- Lever type clamp cylinder gives high clamping force. Manifold or freestanding model available.
- Carbon steel body ensures long life of unit. Ideal for use on CNC machine tools where repetitive clamping is required.

Model	Type	Tube I.D. mm	Stroke mm	Max. operating pressure MPa
MHCK	Standard type	25, 32, 40, 50, 63	25~40	0.5~5
MHCK-F	Manifold type	25, 32, 40, 50, 63	25~40	0.5~5

Hydraulic Swing Clamp Cylinder

MTHS / MTHD series

- Compact design. Available in both clockwise and anti clockwise movement.
- Available in single and double arms. Available in inbuilt flow control.
- Standard angle of rotation: $90^{\circ} \pm 2^{\circ}$ (0° , 45° , 60° are optional)



Model	Double acting / Type	Tube I.D. mm	Swing stroke mm	Clamping stroke mm	Operating pressure MPa
MTHS	Single side clamping arm	25, 32, 40, 50, 63	9, 11, 13	13, 15, 17, 30, 34	0.5~7
MTHS-FC	Single side clamping arm (With flow control)	25, 32, 40, 50, 63	9, 11, 13	13, 15, 17	0.5~7
MTHS-F	Single side clamping arm	25, 32, 40, 50	9, 11, 13	13, 15, 17	0.5~7
MTHS-MF	Single side clamping arm	25, 32, 40, 50, 63	9, 11, 13	13, 15, 17	0.5~7
MTHD	Double sides clamping arm	25, 32, 40, 50, 63	9, 11, 13	13, 15, 17, 30, 34	0.5~7
MTHD-FC	Double sides clamping arm (With flow control)	25, 32, 40, 50, 63	9, 11, 13	13, 15, 17	0.5~7
MTHD-F	Double sides clamping arm	25, 32, 40, 50	9, 11, 13	13, 15, 17	0.5~7
MTHD-MF	Double sides clamping arm	25, 32, 40, 50, 63	9, 11, 13	13, 15, 17	0.5~7

Hydraulic Work Support

MSP series

- Hydraulic work support is used to both minimise vibration during machining and offer increased support.
- A type unit works on the outward stroke with a internal spring.
- B type unit works with oil pressure providing the motive force.



Model	Type	Tube I.D. mm	Stroke mm	Max. operating pressure MPa
MSP-A	Single acting / Spring outward stroke	16	8	10~35
MSP-B	Single acting / Oil pressure motive force	16	8	10~35



MHS* / MHTS* series

- Double clamp retracting, the piston rod rotates, causing the clamping arm to swing in either a clockwise or counterclockwise direction.
- Pull cylinder type, available in rotation angles of 0°, 45°, 60° or 90°.
- The cylinder body is made of aluminum alloy and the surface is hardening treated.

Model	Double acting / Type	Tube I.D. mm	Swivel stroke mm	Clamping stroke mm	Operating pressure MPa
MHS	Single side clamping arm / Flange	25, 32, 40, 50, 63	12, 14	14, 15	2~4.5
MHSD	Double side clamping arm / Flange	25, 32, 40, 50, 63	12, 14	14, 15	2~4.5
MHTS	Single side clamping arm / Threaded	25, 32, 40, 50, 63	12, 14	14, 15	2~4.5
MHTSD	Double side clamping arm / Threaded	25, 32, 40, 50, 63	12, 14	14, 15	2~4.5



MF* / MD* series [High oil pressure]

- Double clamp retracting, the piston rod rotates, causing the clamping arm to swing in either a clockwise or counterclockwise direction.
- Pull cylinder type, available in rotation angles of 0°, 45°, 60° or 90°.
- The cylinder body is made of carbon steel and the surface is hardening treated.

Model	Type	Tube I.D. mm	Swivel stroke mm	Clamping stroke mm	Operating pressure MPa
MFS	Single side clamping arm / Flange	25, 32, 40	12, 15	11, 18	5~21
MDS	Double side clamping arm / Flange	25, 32, 40	12, 15	11, 18	5~21
MFT	Single side clamping arm / Threaded	25, 32, 40	12, 15	11, 18	5~21
MDT	Double side clamping arm / Threaded	25, 32, 40	12, 15	11, 18	5~21

Hydraulic Threaded-Body Cylinder



MTC series

- Simple construction, high strength unit ideal for pushing heavy loads.
- Threaded body design allows quick and easy installation.
- Additional mounting heads can be fitted to the rod.
- Teflon packing ensures zero leakage.

Model	Type	Tube I.D. mm	Stroke mm	Max. operating pressure MPa
MTC-A	Single acting / No thread	12, 16, 20, 25	10, 12, 15, 16	2~35
MTC-B	Single acting / Female thread	12, 16, 20, 25	10, 12, 15, 16	2~35

COMPANY INFORMATION

OVERSEAS DEPARTMENT

No.106, Sec. 3, Chengde Rd., Datong District,
Taipei City 103, Taiwan
TEL : 886-2-25914100
FAX : 886-2-25957633 · 886-2-25975522

OFFICE

No.106, Sec. 3, Chengde Rd., Datong District,
Taipei City 103, Taiwan
TEL : 886-2-25913001 · 886-2-25976201
FAX : 886-2-25912822 · 886-2-25981879



 www.mindman.com.tw  mindman@mindman.com.tw

News

New Product / Design Change Notice / Exhibition Information

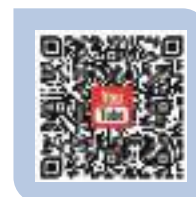
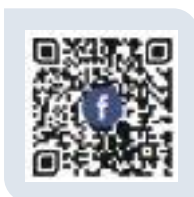

mindman
Connect Your Future

CAT. NO.: MD-G2309-E